



UNIVERSAL ROBOTS

User Manual

UR5e PolyScope X





The information contained herein is the property of Universal Robots A/S and shall not be reproduced in whole or in part without prior written approval of Universal Robots A/S. The information herein is subject to change without notice and should not be construed as a commitment by Universal Robots A/S. This document is periodically reviewed and revised.

Universal Robots A/S assumes no responsibility for any errors or omissions in this document.

Copyright © 2009-2024 by Universal Robots A/S.

The Universal Robots logo is a registered trademark of Universal Robots A/S.



Contents

1. Preface	8
Part I Hardware Installation Manual	11
2. Safety	12
2.1. Validity and Responsibility	13
2.2. Limitation of Liability	13
2.3. Safety Message Types	14
2.4. General Warnings and Cautions	15
2.5. Intended Use	17
2.6. Risk Assessment	20
2.7. Pre-Use Assessment	23
2.8. Emergency Stop	24
2.9. Movement Without Drive Power	25
2.10. Safety-related Functions and Interfaces	26
2.10.1. Stop Categories	26
2.10.2. Configurable Safety Functions	28
2.10.3. Safety Functions	32
2.10.4. Safety Parameter Set	33
2.10.5. Modes	35
3. Mechanical Interface	36
3.1. Workspace and Operating Space	36
3.2. Mounting Description	37
3.3. Securing the Robot Arm	40
3.4. Securing Tool	44
3.5. Control Box Clearance	44
3.6. Maximum Payload	46
4. Electrical Interface	47
4.1. Electrical Warnings and Cautions	47
4.2. Controller I/O	49
4.3. Safety I/O	51
4.4. Three Position Enabling Device	56
4.5. General Purpose Digital I/O	57
4.6. General Purpose Analog I/O	58
4.7. Remote ON/OFF Control	59
4.8. Control Box Connection Ports	61
4.9. Ethernet	61
4.10. Mains Connections	62



4.11. Robot Connections: Robot Cable	64
4.12. Robot Connections: Base Flange Cable	66
4.13. Tool I/O	67
4.14. Tool Power Supply	69
4.15. Tool Digital Outputs	70
4.16. Tool Digital Inputs	71
4.17. Tool Analogue Inputs	71
4.18. Tool Communication I/O	72
5. Transportation	73
5.1. Transport Without Packaging	74
6. Maintenance and Repair	75
7. Robot Arm Cleaning and Inspection	76
8. Disposal and Environment	80
9. Certifications	82
10. Stopping Time and Stopping Distance	84
11. Declarations and Certificates (original EN)	89
12. Warranty Information	91
13. Certificates	92
14. Applied Standards	97
15. Technical Specifications UR5e	106
16. Safety Functions Table 1	107
16.1. Table 1a	115
16.2. Table 2	116
Part II PolyScope X Software Manual	122
17. Preface	130
17.1. What Do the Boxes Contain	131
17.2. Important Safety Notice	131
17.3. How to Read this Manual	131
17.4. Purpose of this Manual	132
18. Robot Arm Basics	133
18.1. Teach Pendant	133
18.1.1. Using the screen	133
19. Install the robot	134
19.1. Assembling the robot arm and Control Box	134
20. PolyScope X Overview	135
20.0.1. Screen Layout	135
20.0.2. Screen Combinations	135

20.1. Touch Screen	136
20.2. Icons	137
21. Initialize	139
21.1. Starting the Robot Arm	139
21.2. Safely Setting the Active Payload	139
22. Safety	140
22.1. Safety Checksum	140
22.2. Safety Configuration	140
22.3. Setting a Safety Password	140
22.4. Safety Menu Settings	141
22.4.1. Robot Limits	141
22.4.2. Safety I/O Signals	142
22.4.3. Safety Planes	144
To restrict the elbow joint	145
23. Operational Mode	146
24. Application Tab	148
24.1. Communication	148
25. Glossary	150
25.1. Index	151

1. Preface

Introduction

Congratulations on the purchase of your new Universal Robots robot, which consists of the robot arm (manipulator), Control Box and the Teach Pendant.

Originally designed to mimic the range of motion of a human arm, the robot arm is composed of aluminium tubes, articulated by six joints, allowing for a high range of flexibility in your automation installation.

The Universal Robots patented programming interface, PolyScope, allows you to create, load and run your automation applications.



What Do the Boxes Contain

When you order a robot, you receive two boxes. One contains the Robot Arm, the other contains:

- Control Box with Teach Pendant
- Mounting bracket for the Control Box
- Mounting bracket for the Teach Pendant
- Key for opening the Control Box
- Cable for connecting the robot arm and the Control Box (see options in [15 Technical Specifications UR5e on page 106](#))
- Mains cable or Power cable compatible to your regions
- This manual

Important Safety Notice

The robot is **partly completed machinery** (see [Declarations according to EU directives on page 83](#)) and as such a risk assessment is required for each installation of the robot. You must follow all of the safety instructions in [chapter 2 Safety on page 12](#).

About the robot arm

The Joints, Base and Tool Flange are the main components of the robot arm.

The controller coordinates joint motion to move the robot arm.

Attaching an end effector (tool) to the Tool Flange at the end of the robot arm, allows the robot to manipulate a workpiece. Some tools have a specific purpose beyond manipulating a part, for example, QC inspection, applying adhesives and welding.

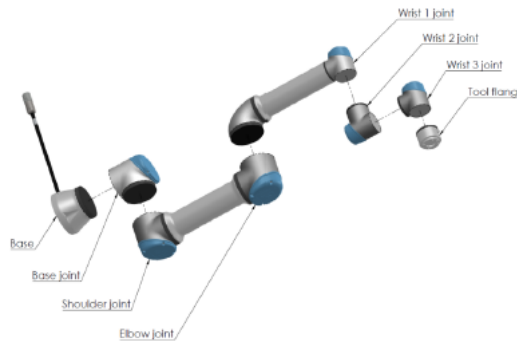

2.1: The main components of the robot arm.

- **Base:** where the robot arm is mounted.
- **Shoulder and Elbow:** make larger movements.
- **Wrist 1 and Wrist 2:** make finer movements.
- **Wrist 3:** where the tool is attached to the Tool Flange.

The robot is partly completed machinery, as such a Declaration of Incorporation is provided. A risk assessment is required for each robot application.

About the manual

This manual contains safety information, guidelines for safe use, and instructions to mount the robot arm, Control Box and Teach Pendant. You can also find instructions for how to begin to install and how to start programming the robot.

Read and adhere to the intended uses. Perform a risk assessment. Install and use in accordance with the electrical and mechanical specifications provided in this user manual.

Risk assessment requires an understanding of the hazards, risks and risk reduction measures for the robot application. Robot integration can require a basic level of mechanical and electrical training.

Content disclaimer

Universal Robots A/S continues to improve the reliability and performance of its products, and as such reserves the right to upgrade products, and product documentation, without prior warning. Universal Robots A/S takes every care to ensure the content of the User Manual/s is precise and correct, but takes no responsibility for any errors or missing information.

This manual does not contain warranty information.

myUR

The myUR portal allows you to register all your robots, keep track of service cases and answer general support questions.

Sign into myur.universal-robots.com to access the portal.

In the myUR portal, your cases are handled either by your preferred distributor, or escalated to Universal Robots Customer Service teams. You can also subscribe to robot monitoring and manage additional user accounts in your company.

Support

The support site www.universal-robots.com/support contains other language versions of this manual

UR+

The online showroom UR+ www.universal-robots.com/plus provides cutting-edge products to customize your UR robot application. You can find everything you need in one place – from tools and accessories to software.

UR+ products connect to and work with UR robots to ensure simple set-up and an overall smooth user experience. All UR+ products are tested by UR.

You can also access the UR+ Partner Program via our software platform plus.universal-robots.com to design more user-friendly products for UR robots.

UR forums

The UR Forum forum.universal-robots.com allows robot enthusiasts of all skill levels to connect to UR and each other, to ask questions and to exchange information. While the UR Forum was created by UR+ and our admins are UR employees, the majority of the content is created by you, the UR Forum user.

Academy

The UR Academy site academy.universal-robots.com offers a variety of training opportunities.

Developer suite

The UR Developer Suite universal-robots.com/products/ur-developer-suite is a collection of all the tools needed to build an entire solution, including developing URCaps, adapting end-effectors, and integrating hardware.

Part I

Hardware Installation Manual

2. Safety

Description

Read the general safety information and the instructions and guidance pertaining to the risk assessment and intended use provided. Give particular attention to text accompanied by warning symbols. Subsequent sections describe and define safety-related functions particularly relevant for collaborative applications.

Read and understand the specific engineering data relevant to mounting and installation, in order to understand the integration of UR robots before the robot is powered on for the first time.

It is essential to observe and follow all assembly instructions in the following sections of this manual.



NOTICE

Universal Robots disclaims any and all liability if the robot (arm Control Box with or without Teach Pendant) is damaged, changed or modified in any way. Universal Robots cannot be held responsible for any damages caused to the robot or any other equipment due to programming errors, unauthorized access to the UR robot and its contents, or malfunctioning of the robot.

2.1. Validity and Responsibility

Description

The information in this manual does not cover designing, installing, integrating and operating a robot application, nor does it cover all peripheral equipment that can influence the safety of the robot application. The robot application must be designed and installed in accordance with the safety requirements set forth in the relevant standards and regulations of the country where the robot is installed.

The person/s integrating the UR robot are responsible for ensuring that the applicable regulations in the country concerned are observed and that any risks in the robot application are adequately reduced. This includes, but is not limited to:

- Performing a risk assessment for the complete robot system
 - Interfacing other machines and additional safeguarding if required by the risk assessment
 - Setting the correct safety settings in the software
 - Ensuring safety measures are not modified
 - Validating the robot application is designed, and installed and integrated
 - Specifying instructions for use
 - Marking the robot installation with relevant signs and contact information of the integrator
 - Retaining all documentation; including the application risk assessment, this manual and additional relevant documentation.
-

2.2. Limitation of Liability

Description

Any information provided in this manual must not be construed as a warranty, by UR, that the industrial robot will not cause injury or damage, even if the industrial robot complies with all safety instructions and information for use.

2.3. Safety Message Types

Description

Safety messages are used to emphasize important information. Read all the messages to help ensure safety and to prevent injury to personnel and product damage. The safety message types are defined below.



WARNING

Indicates a hazardous situation that, if not avoided, can result in death or serious injury.



WARNING: ELECTRICITY

Indicates a hazardous electrical situation that, if not avoided, can result in death or serious injury.



WARNING: HOT SURFACE

Indicates a hazardous hot surface where injury can result from contact and non-contact proximity.



CAUTION

Indicates a hazardous situation that, if not avoided, can result in injury.



GROUND

Indicates grounding.



PROTECTIVE GROUND

Indicates protective grounding.



NOTICE

Indicates the risk of damage to equipment and/or information to be noted.



READ MANUAL

Indicates more detailed information that should be consulted in the manual.

2.4. General Warnings and Cautions

Description

The following warnings messages can be repeated, explained or detailed in subsequent sections.



WARNING

Failure to adhere to the general safety practices, listed below, can result in injury or death.

- Verify the robot arm and tool/end effector are properly and securely bolted in place.
- Verify the robot application has ample space to operate freely.
- Verify the personnel are protected during the lifetime of the robot application including transport, installation, commissioning, programming/ teaching, operation and use, dismantling and disposing.
- Verify robot safety configuration parameters are set to protect personnel, including those who can be within reach of the robot application.
- Avoid using the robot if it is damaged.
- Avoid wearing loose clothing or jewelry when working with the robot. Tie back long hair.
- Avoid placing any fingers behind the internal cover of the Control Box.
- Inform users of any hazardous situations and the protection that is provided, explain any limitations of the protection and the residual risks.
- Inform users of the location of the emergency stop button(s) and how to activate the emergency stop in case of an emergency or an abnormal situation.
- Warn people to keep outside the reach of the robot, including when the robot application is about to start-up.
- Be aware of robot orientation to understand the direction of movement when using the Teach Pendant.
- Adhere to the requirements and guidance in ISO 10218-2.



WARNING

Handling tools/end effectors with sharp edges and/or pinch points can result in injury.

- Make sure tools/end effectors have no sharp edges or pinch points.
- Protective gloves and/or protective eyeglasses could be required.

WARNING: HOT SURFACE

Prolonged contact with the heat generated by the robot arm and the Control Box, during operation, can lead to discomfort resulting in injury.

- Do not handle or touch the robot while in operation or immediately after operation.
- Check the temperature on the log screen before handling or touching the robot.
- Allow the robot to cool down by powering it off and waiting one hour.

CAUTION

Failure to perform a risk assessment prior to integration and operation can increase risk of injury.

- Perform a risk assessment and reduce risks prior to operation.
- If determined by the risk assessment, do not enter the range of the robot movement or touch the robot application during operation. Install safeguarding.
- Read the risk assessment information.

CAUTION

Using the robot with untested external machinery, or in an untested application, can increase the risk of injury to personnel.

- Test all functions and the robot program separately.
- Read the commissioning information.

NOTICE

Very strong magnetic fields can damage the robot.

- Do not expose the robot to permanent magnetic fields.

READ MANUAL

Verify all mechanical and electrical equipment is installed according to relevant specifications and warnings.

2.5. Intended Use

Description



READ MANUAL

Failure to use the robot in accordance with the intended use can result in hazardous situations.

- Read and follow the recommendations for intended use and the specifications provided in the User Manual.

Universal Robots robots are intended for industrial use, to handle tools/end effectors and fixtures, or to process or transfer components or products. For details about the conditions under which the robot should operate.

All UR robots are equipped with safety functions, which are purposely designed to enable collaborative applications, where the robot application operates together with a human. The safety function settings must be set to the appropriate values as determined by the robot application risk assessment.

Collaborative applications are only intended for non-hazardous applications, where the complete application, including tool/end effector, work piece, obstacles and other machines, is low risk according to the risk assessment of the specific application.



WARNING

Using UR robots or UR products outside of the intended uses can result in injuries, death and/or property damage. Do not use the UR robot or products for any of the below unintended uses and applications:

- Medical use, i.e. uses relating to disease, injury or disability in humans including the following purposes:
 - Rehabilitation
 - Assessment
 - Compensation or alleviation
 - Diagnostic
 - Treatment
 - Surgical
 - Healthcare
 - Prosthetics and other aids for the physically impaired
 - Any use in proximity to patient/s
- Handling, lifting, or transporting people
- Any application requiring compliance with specific hygienic and/or sanitation standards, such as proximity or direct contact with food, beverage, pharmaceutical, and /or cosmetic products.
 - UR joint grease can be released into the air (vapor), or drip.
- Any use, or any application, deviating from the intended use, specifications, and certifications of UR robots or UR products.
- Misuse is prohibited as the result could be death, personal injury, and /or property damage

UNIVERSAL ROBOTS EXPRESSLY DISCLAIMS ANY EXPRESS OR IMPLIED WARRANTY OF FITNESS FOR ANY PARTICULAR USE.



WARNING

Do not modify the robot. Do not modify or alter e-Series end caps. A modification can create unforeseen hazards. All authorized disassembling and reassembling shall be done at a UR service center, or can be done according to the newest version of all relevant service manuals by skilled persons.

**WARNING**

Failure to consider the added risks due to the reach, payloads, operating torques and speeds associated with robot application, can result in injury or death.

- Your application risk assessment shall include the risks associated with the application's reach, motion, payload and speed of the robot, end effector and workpiece.

2.6. Risk Assessment

Description

The risk assessment is a requirement that shall be performed for the application. The application risk assessment is the responsibility of the integrator. The user can also be the integrator.

The robot is partly completed machinery, as such the safety of the robot application depends on the tool/end effector, obstacles and other machines. The party performing the integration must use ISO 12100 and ISO 10218-2 to conduct the risk assessment. Technical Specification ISO/TS 15066 can provide additional guidance for collaborative applications. The risk assessment shall consider all tasks throughout the lifetime of the robot application, including but not limited to:

- Teaching the robot during set-up and development of the robot application
- Troubleshooting and maintenance
- Normal operation of the robot application

A risk assessment must be conducted **before** the robot application is powered on for the first time. The risk assessment is an iterative process. After physically installing the robot, verify the connections, then complete the integration. A part of the risk assessment is to determine the safety configuration settings, as well as the need for additional emergency stops and/or other protective measures required for the specific robot application.

Safety configuration settings

Identifying the correct safety configuration settings is a particularly important part of developing robot applications. Unauthorized access to the safety configuration must be prevented by enabling and setting password protection.



WARNING

Failure to set password protection can result in injury or death due to purposeful or inadvertent changes to configuration settings.

- Always set password protection.
- Set up a program for managing passwords, so that access is only by persons who understand the effect of changes.

Some safety functions are purposely designed for collaborative robot applications. These are configurable through the safety configuration settings. They are used to address risks identified in the application risk assessment.

The following limit the robot and as such can affect the energy transfer to a person by the robot arm, end effector and workpiece.

- **Force and power limiting:** Used to reduce clamping forces and pressures exerted by the robot in the direction of movement in case of collisions between the robot and the operator.
- **Momentum limiting:** Used to reduce high transient energy and impact forces in case of collisions between robot and operator by reducing the speed of the robot.
- **Speed limitation:** Used to ensure the speed is less than the configured limit.

The following orientation settings are used to avoid movements and reduce exposure of sharp edges and protrusions to a person.

- **Joint, elbow and tool/end effector position limiting:** Used to reduce risks associated with certain body parts: Avoid movement towards head and neck.
- **Tool/end effector orientation limiting:** Used to reduce risks associated with certain areas and features of the tool/end effector and work-piece: Avoid sharp edges being pointed towards the operator, by turning the sharp edges inward towards the robot.

Stopping performance risks

Some safety functions are purposely designed for any robot application. These features are configurable through the safety configuration settings. They are used to address risks associated with the stopping performance of the robot application.

The following limit the robot stopping time and stopping distance to ensure stopping will occur before reaching the configured limits. Both settings automatically affect the speed of the robot to ensure the limit is not exceeded.

- **Stopping Time Limit:** Used to limit the stopping time of the robot.
- **Stopping Distance Limit:** Used to limit the stopping distance of the robot.

If either of the above is used, there is no need for manually performed periodic stopping performance testing. The robot safety control does continuous monitoring.

If the robot is installed in a robot application where hazards cannot be reasonably eliminated or risks cannot be sufficiently reduced by use of the built-in safety-related functions (e.g. when using a hazardous tool/end effector, or hazardous process), then safeguarding is required.



WARNING

Failure to conduct a application risk assessment can increase risks.

- Always conduct an application risk assessment for foreseeable risks and reasonably foreseeable misuse.

For collaborative applications, the risk assessment includes the foreseeable risks due to collisions and to reasonably foreseeable misuse.

The risk assessment shall address:

- Severity of harm
- Likelihood of occurrence
- Possibility to avoid the hazardous situation

Potential hazards Universal Robots identifies the potential significant hazards listed below for consideration by the integrator. Other significant hazards can be associated with a specific robot application.

- Penetration of skin by sharp edges and sharp points on tool/end effector or tool/end effector connector.
- Penetration of skin by sharp edges and sharp points on nearby obstacles.
- Bruising due to contact.
- Sprain or bone fracture due to impact.
- Consequences due to loose bolts that hold the robot arm or tool/end effector.
- Items falling out of, or flying from the tool/end effector, e.g. due to a poor grip or power interruption.
- Mistaken understanding of what is controlled by multiple emergency stop buttons.
- Incorrect setting of the safety configuration parameters.
- Incorrect settings due to unauthorized changes to the safety configuration parameters.

2.7. Pre-Use Assessment

Description The following tests must be conducted before using the robot application for the first time or after making any modifications.

- Verify all safety inputs and outputs are correctly connected.
- Test all connected safety input and output, including devices common to multiple machines or robots, are functioning as intended.
- Test emergency stop buttons and inputs to verify the robot stops and the brakes engage.
- Test safeguard inputs to verify the robot motion stops. If safeguard reset is configured, check that it functions as intended.
- Look at the initialization screen, activate the reduced input and verify the screen changes.

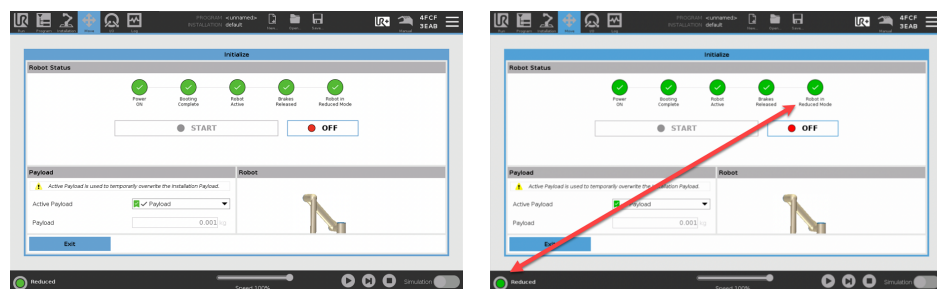

- Change the operational mode to verify the mode icon changes in top right corner of PolyScope screen.
- Test the 3-position enabling device to verify that pressing to the center on position enables motion in manual mode at a reduced speed.
- If the Emergency Stop outputs are used, press the Emergency Stop push-button and verify that there is a stop of the whole system.
- Test the system connected to Robot Moving output, Robot Not Stopping output, Reduced Mode output, or Not Reduced Mode output to verify the output changes are detected.
- Determine the commissioning requirements of your robot application.

2.8. Emergency Stop

Description

The Emergency Stop or E-stop is the red push-button located on the Teach Pendant. Press the emergency stop push-button to stop all robot motion. Activating the emergency stop push-button causes a stop category one (IEC 60204-1). Emergency stops are not safeguards (ISO 12100).

Emergency stops are complementary protective measures that do not prevent injury. The risk assessment of the robot application determines if additional emergency stop push-buttons are required. The emergency stop function and the actuating device must comply with ISO 13850.

After an emergency stop is actuated, the push-button latches in that setting. As such, each time an emergency stop is activated, it must be manually reset at the push-button that initiated the stop.

Before resetting the emergency stop push-button, you must visually identify and assess the reason the E-stop was first activated. Visual assessment of all the equipment in the application is required. Once the problem is solved, reset the emergency stop push-button.

To reset the emergency stop push-button

1. Hold the push-button and twist clockwise until the latching disengages.
You should feel when the latching is disengaged, indicating the push-button is reset.
 2. Verify the situation and whether to reset the emergency stop.
 3. After resetting the emergency stop, restore power to the robot and resume operation.
-

2.9. Movement Without Drive Power

Description

In the unlikely event of an emergency, when powering the robot is either impossible or unwanted, you can use forced back-driving to move the robot arm.

To perform forced back-driving you must push, or pull, the robot arm hard to move the joint. Each joint brake has a friction clutch that enables movement during high forced torque.

Performing forced back-driving requires high force and cannot be performed by one person alone. In clamping situations, two or more people are required to do the forced back-driving. In some situations, two or more people are required to disassemble the robot arm.



WARNING

Risks due to an unsupported robot arm breaking or falling can cause injury or death.

- Support the robot arm before removing power.



NOTICE

Moving the robot arm manually is intended for emergency and service purposes only. Unnecessary moving of the robot arm can lead to property damage.

- Do not move the joint more than 160 degrees, to ensure the robot can find its original physical position.
- Do not move any joint more than necessary.

2.10. Safety-related Functions and Interfaces

Description

Universal Robots robots are equipped with a range of built-in safety functions as well as safety I/O, digital and analog control signals to or from the electrical interface, to connect to other machines and additional protective devices. Each safety function and I/O is constructed according to EN ISO13849-1 with Performance Level d (PLd) using a category 3 architecture.



WARNING

The use of safety configuration parameters different from those determined as necessary for risk reduction, can result in hazards that are not reasonably eliminated, or risks that are not sufficiently reduced.

- Ensure tools and grippers are connected correctly to avoid hazards due to interruption of power.



WARNING: ELECTRICITY

Programmer and/or wiring errors can cause the voltage to change from 12V to 24V leading to fire damage to equipment.

- Verify the use of 12V and proceed with caution.



NOTICE

- The use and configuration of safety functions and interfaces must follow the risk assessment procedures for each robot application.
- The stopping time should be taken into account as part of the application risk assessment
- If the robot detects a fault or violation in the safety system (e.g. if one of the wires in the Emergency Stop circuit is cut or a safety limit is exceeded), then a Stop Category 0 is initiated.



NOTICE

The end effector is not protected by the UR safety system. The functioning of the end effector and/or connection cable is not monitored

2.10.1. Stop Categories

Description

Depending on the circumstances, the robot can initiate three types of stop categories defined according to IEC 60204-1. These categories are defined in the following table.

Stop Category	Description
0	Stop the robot by immediate removal of power.
1	Stop the robot in an orderly, controlled manner. Power is removed once the robot is stopped.
2	*Stop the robot with power available to the drives, while maintaining the trajectory. Drive power is maintained after the robot is stopped.

*Universal Robots robots' Category 2 stops are further described as SS1 or as SS2 type stops according to IEC 61800-5-2.

2.10.2. Configurable Safety Functions

Description

Universal Robots robot safety functions, as listed in the table below, are in the robot but are meant to control the robot system i.e. the robot with its attached tool/end effector. The robot safety functions are used to reduce robot system risks determined by the risk assessment. Positions and speeds are relative to the base of the robot.

Safety Function	Description
Joint Position Limit	Sets upper and lower limits for the allowed joint positions.
Joint Speed Limit	Sets an upper limit for joint speed.
Safety Planes	Defines planes, in space, that limit robot position. Safety planes limit either the tool/end effector alone or both the tool/end effector and the elbow.
Tool Orientation	Defines allowable orientation limits for the tool.
Speed Limit	Limits maximum robot speed. The speed is limited at the elbow, at the tool/end effector flange, and at the center of the user-defined tool/end effector positions.
Force Limit	Limits maximum force exerted by the robot tool/end effector and elbow in clamping situations. The force is limited at the tool/end effector, elbow flange and center of the user-defined tool/end effector positions.
Momentum Limit	Limits maximum momentum of the robot.
Power Limit	Limits mechanical work performed by the robot.
Stopping Time Limit	Limits maximum time the robot uses for stopping after a robot stop is initiated. ¹
Stopping Distance Limit	Limits maximum distance travelled by the robot after a robot stop is initiated.

Safety Function

When performing the application risk assessment, it is necessary to take into account the motion of the robot after a stop has been initiated. In order to ease this process, the safety functions *Stopping Time Limit* and *Stopping Distance Limit* can be used. These safety functions dynamically reduces the speed of the robot motion such that it can always be stopped within the limits. The joint position limits, the safety planes and the tool/end effector orientation limits take the expected stopping distance travel into account i.e. the robot motion will slow down before the limit is reached. The functional safety can be summarized as:

¹Robot stop was previously known as "Protective stop".

Table

Safety Function	Accuracy	Performance Level	Category
Emergency Stop	-	d	3
Safeguard Stop	-	d	3
Joint Position Limit	5 °	d	3
Joint Speed Limit	1.15 °/s	d	3
Safety Planes	40 mm	d	3
Tool Orientation	3 °	d	3
Speed Limit	50 mm/s	d	3
Force Limit	25 N	d	3
Momentum Limit	3 kg m/s	d	3
Power Limit	10 W	d	3
Stopping Time Limit	50 ms	d	3
Stopping Distance Limit	40 mm	d	3
Safe Home	1.7 °	d	3

Warnings

**CAUTION**

Failure to configure the maximum speed limit can result in hazardous situations.

- If the robot is used in manual hand-guiding applications with linear movements, the speed limit must be set to maximum 250 mm/s for the tool/end effector and elbow unless a risk assessment shows that higher speeds are acceptable. This will prevent fast movements of the robot elbow near singularities.

**NOTICE**

There are two exceptions to the force limiting function that are important when designing an application.

As the robot stretches out, the knee-joint effect can give high forces in the radial direction (away from the base) at low speeds. Similarly, the short leverage arm, when the tool/end effector is close to the base and moving around the base, can cause high forces at low speeds.

Workspace

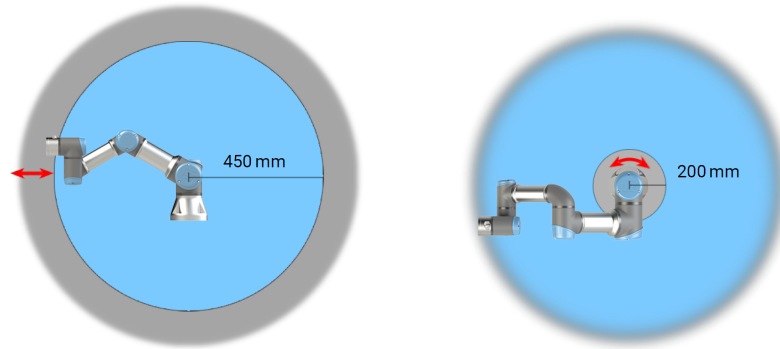

2.1: Due to the physical properties of the robot arm, certain workspace areas require attention regarding pinching hazards. One area (left) is defined for radial motions when the wrist 1 joint is at least 450 mm from the base of the robot. The other area (right) is within 200 mm of the base of the robot, when moving tangentially.

Placing the robot in certain areas can create pinching hazards that can lead to injury.

Safety inputs

The robot also has the following safety inputs:

Safety Input	Description
Emergency Stop Button	Performs a Stop Category 1 (IEC 60204-1) informing other machines using the <i>System Emergency Stop</i> output, if that output is defined. A stop is initiated in anything connected to the output.
Robot Emergency Stop	Performs a Stop Category 1 (IEC 60204-1) via Control Box input, informing other machines using the <i>System Emergency Stop</i> output, if that output is defined.
System Emergency Stop	Performs a Stop Category 1 (IEC 60204-1) on robot only, in all modes and takes precedence over all other commands.
Safeguard Stop	Performs a Stop Category 2 (IEC 60204-1) in all modes, except when using a 3-Position Enabling Device and a mode selector - then when in Manual Mode, the Safeguard Stop can be set to only function in Automatic Mode.
Automatic Mode Safeguard Stop	Performs a Stop Category 2 (IEC 60204-1) in Automatic mode ONLY. <i>Automatic Mode Safeguard Stop</i> can only be selected when a Three-Position Enabling Device is configured and installed.
Safeguard Reset	Returns from the <i>Safeguard Stop</i> state, when a rising edge on the Safeguard Reset input occurs.
Reduced Mode	Transitions the safety system to use the <i>Reduced mode</i> limits.
Three-Position Enabling Device	Initiates a Stop Category 2 (IEC 60204-1) when the enabling device is fully pressed or fully released in manual mode only. Three-Position Enabling Device Stop is triggered when an input goes low. It is unaffected by a Safeguard Reset.
Freedrive on robot	Enables freedrive, when the robot is not in Automatic Mode.
Operational Mode	Switches between Operational modes. The robot is in Automatic mode when input is low, Manual mode when input is high.
Automatic Mode Safeguard Reset	Returns from the <i>Automatic Mode Safeguard Stop</i> state, when a rising edge on the Automatic Mode Safeguard Reset input occurs.

Safety outputs

For interfacing with other machines, the robot is equipped with the following safety outputs:

Safety Output	Description
System Emergency Stop	While this signal is logic low, the <i>Robot Emergency Stop</i> input is logic low or the Emergency Stop button is pressed.
Robot Moving	While this signal is logic high, no single joint of the robot moves more than 0.1 rad/s.
Robot Not Stopping	Logic high when the robot is stopped or in the process of stopping due to an Emergency Stop or Safeguard Stop. Otherwise it will be logic low.
Reduced	Logic low when the safety system is in Reduced Mode.
Not Reduced	Logic low when the system is not in Reduced Mode.
Safe Home	Logic high when robot is in the configured Safe Home Position.

All safety I/O are dual channel, meaning they are safe when low (e.g., the Emergency Stop is active when the signals are low).

2.10.3. Safety Functions

Description

The safety system acts by monitoring if any of the safety limits are exceeded or if an Emergency Stop or a Safeguard Stop is initiated.

The reactions of the safety system are:

Trigger	Reaction
Emergency Stop	Stop Category 1
Safeguard Stop	Stop Category 2
3PE Stop (if a 3-Position Enabling device is connected)	Stop Category 2
Limit Violation	Stop Category 0
Fault Detection	Stop Category 0



NOTICE

If the safety system detects any fault or violation, all safety outputs re-set to low.

2.10.4. Safety Parameter Set

Description

The safety system has the following set of configurable safety parameters:

- Normal
 - Reduced
-

Normal and Reduced

You can set up the safety limits for each set of safety parameters, creating distinct configurations for normal, or higher settings, and reduced. The reduced configuration is active when the tool/end effector is positioned on the reduced side of a Trigger Reduced Plane, or when the reduced configuration is externally triggered by a safety input.

Using a plane to trigger the Reduced configuration: When the robot arm moves from the side of the trigger plane configured with reduced safety parameters, to the side that is configured with normal safety parameters, there is a 20 mm area around the trigger plane where both normal and reduced limits are allowed. This area around the trigger plane prevents nuisance safety stops when the robot is exactly at the limit.

Using an input to trigger the Reduced configuration: When a safety input starts, or stops, the reduced configuration, up to 500 ms can elapse before the new limit values become active. This can happen in either of the following circumstances:

- Switching from the reduced configuration to normal
- Switching from the normal configuration to reduced

The robot arm adapts to the new safety limits within the 500 ms.

Recovery

When a safety limit is exceeded, the safety system must be restarted. For example, if a joint position limit is outside a safety limit, at start-up, Recovery is activated. You cannot run programs for the robot when recovery is activated, but the robot arm can be manually moved back within limits using Freedrive, or by using the Move tab in PolyScope.

The safety limits for Recovery are:

Safety Function	Limit
Joint Speed Limit	30 °/s
Speed Limit	250 mm/s
Force Limit	100 N
Momentum Limit	10 kg m/s
Power Limit	80 W

The safety system issues a Stop Category 0 if a violation of these limits appears.



WARNING

Failure to use caution when moving the robot arm in recovery mode can lead to hazardous situations.

- Use caution when moving the robot arm back within the limits, as limits for the joint positions, the safety planes, and the tool/end effector orientation are all disabled in recovery mode.

2.10.5. Modes

Description

When a safety limit is exceeded, Recovery Mode is automatically activated, allowing the robot arm to be moved. Recovery Mode is a type of Manual Mode . You cannot run robot programs when Recovery Mode is active.

During Recovery Mode, the robot arm is moved to be within joint limits, using either Freedrive or the Move tab in PolyScope.

Safety limits of Recovery Mode

Safety Function	Limit
Joint Speed Limit	30 °/s
Speed Limit	250 mm/s
Force Limit	100 N
Momentum Limit	10 kg m/s
Power Limit	80 W

The safety system issues a Stop Category 0 if a violation of these limits appears.



WARNING

Failure to use caution when moving the robot arm in recovery mode can lead to hazardous situations.

- Use caution when moving the robot arm back within the limits, as limits for the joint positions, the safety planes, and the tool/end effector orientation are all disabled in recovery.

3. Mechanical Interface

Description

The elements of the robot make up the robot system: Robot arm, tool or workpiece, Control Box and 3PE Teach Pendant are described in this chapter. You can also find maximum payload and workspace requirements.

For information about adding the serial number during first boot, please see the "Robot Arm Installation" in the software section.

3.1. Workspace and Operating Space

Description

The workspace is the range of the fully extended robot arm, horizontally and vertically. The operating space is the location where the robot is expected to function.



NOTICE

Disregard for the robot workspace and operating space can result in the damage to property.

- Consider the information below when choosing the operating space for the robot.



NOTICE

Moving the tool close to the cylindrical volume can cause the joints to move too fast, leading to loss of functionality and damage to property.

- Do not move the tool close to the cylindrical volume, even when the tool is moving slowly.
-

Workspace

The cylindrical volume is both directly above and directly below the robot base. The robot extends 850 mm from the base joint.

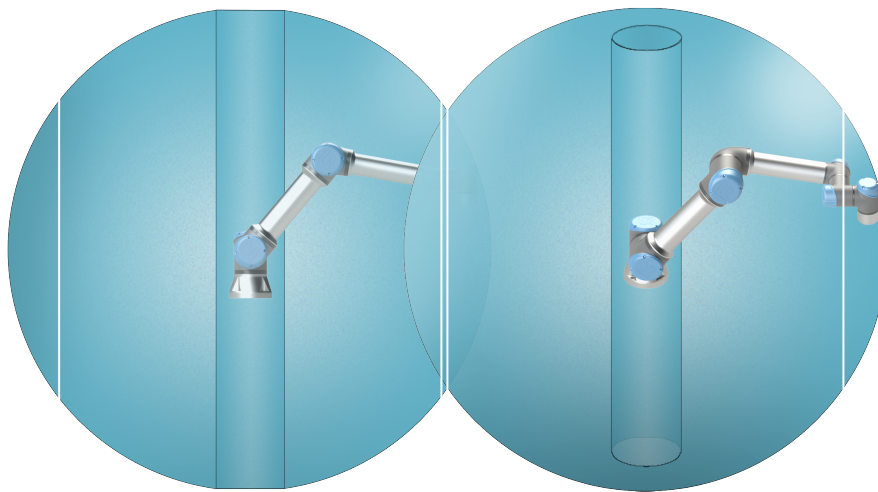

Front

Tilted

3.2. Mounting Description

Description

Robot arm (Base)	Mounted with four 8.8 strength, M8 bolts and four 8.5 mm mounting holes at the base.
Tool (Tool Flange)	Uses four M6 thread holes for attaching a tool to the robot. The M6 bolts shall be tightened with 8 Nm, strength class 8.8. For accurate tool repositioning, use a pin in the Ø6 hole provided.
Control Box	The Control Box can be hung on a wall or placed on the ground.
Teach Pendant	The Teach Pendant is wall mounted or placed onto the Control Box. Verify the cable does not cause tripping hazard. You can buy extra brackets for mounting the Control Box and Teach Pendant.

CAUTION

Mounting and operating the robot in environments exceeding the recommended IP rating can result in injury.

- Mount the robot in an environment suited to the IP rating. The robot must not be operated in environments that exceed those corresponding to the IP ratings of the robot (IP54), Teach Pendant (IP54) and Control Box (IP44)



WARNING

Unstable mounting can lead to accidents.

- Always make sure the robot parts are properly and securely mounted and bolted in place.

3.3. Securing the Robot Arm

Description

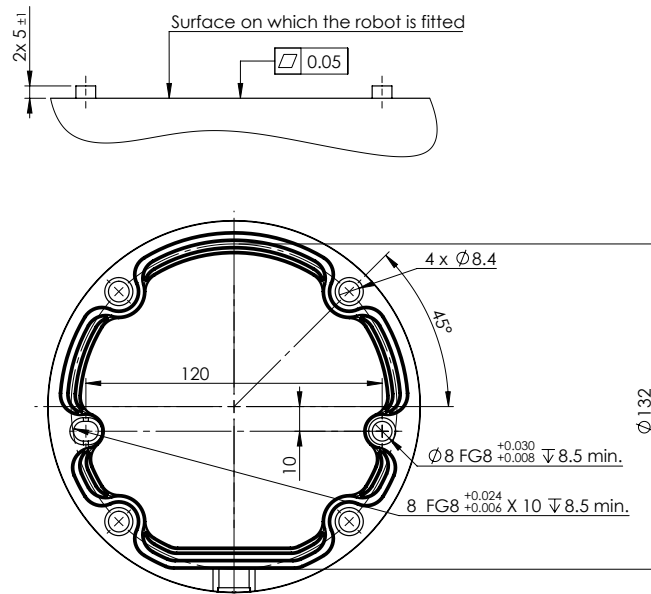

2.2: Dimensions and hole pattern for mounting the robot.

To power down the robot arm



WARNING

Unexpected start-up and/or movement can lead to injury

- Power down the robot arm to prevent unexpected start-up during mounting and dismounting.

1. Press the power button on the Teach Pendant to turn off the robot.
2. Unplug the mains cable / power cord from the wall socket.
3. Allow 30 seconds for the robot to discharge any stored energy.

To secure the robot arm

1. Place the robot arm on the surface on which it is to be mounted. The surface must be even and clean.
2. Tighten the four 8.8 strength, M8 bolts to a torque of 20 Nm. (Torque values have been updated SW 5.18. Earlier printed version will show different values)
3. If accurate re-mounting of the robot is required, use the Ø8 mm. hole and Ø8x13 mm. slot with corresponding ISO 2338 Ø8 h6 positioning pins in the mounting plate.

Dimensioning the stand

The structure (stand) on which the robot arm is mounted is a crucial part of the robot installation. The stand must be sturdy and free of any vibrations from external sources.

Each robot joint produces a torque that moves and stops the robot arm. During normal uninterrupted operation and during stopping motion, the joint torques are transferred to the robot stand as:

- M_z : Torque around the base z axis.
- F_z : Forces along base z axis.
- M_{xy} : Tilting torque in any direction of the base xy plane.
- F_{xy} : Force in any direction in the base xy plane.

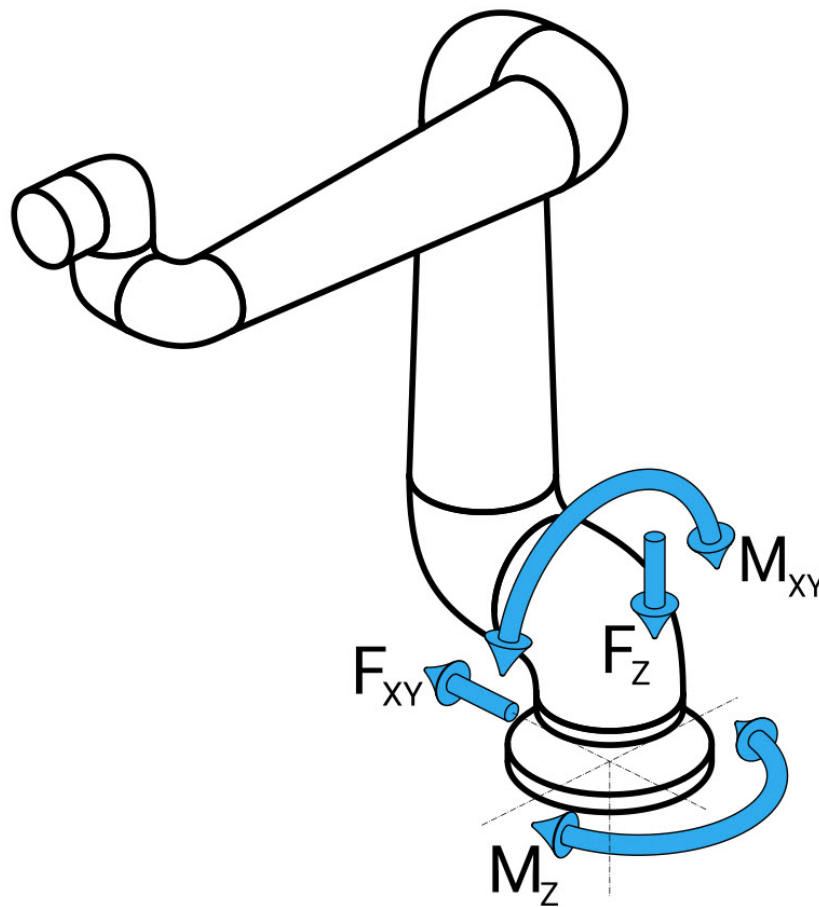

Force and moment at base flange definition.

Dimensioning the Stand

The magnitude of the loads depends on robot model, program and multiple other factors. Dimensioning of the stand shall account for the loads that the robot arm generates during normal uninterrupted operation and during category 0, 1 and 2 stopping motion. During stopping motion, the joints are allowed to exceed the maximum nominal operating torque. The load during stopping motion is independent of the stop category type. The values stated in the following tables are maximum nominal loads in worst-case movements multiplied with a safety factor of 2.5. The actual loads will not exceed these values.

Robot Model	Mz [Nm]	Fz[Nm]	M _{xy} [Nm]	F _{xy} [Nm]
UR5e	450	1090	750	910

Maximum joint torques during category 0, 1 and 2 stops.

Robot Model	Mz [Nm]	Fz[Nm]	M _{xy} [Nm]	F _{xy} [Nm]
UR5e	380	950	630	750

Maximum joint torques during normal operation.

The normal operating loads can generally be reduced by lowering the acceleration limits of the joints. Actual operating loads are dependent on the application and robot program. You can use URSim to evaluate the expected loads in your specific application.

Dimensioning the Stand Users have the option to incorporate added safety margins, factoring in the following design considerations:

- **Static stiffness:** A stand that is not sufficiently stiff will deflect during robot motion, resulting in the robot arm not hitting the intended waypoint or path. Lack of static stiffness can also result in a poor freedrive teaching experience or protective stops.
- **Dynamic stiffness:** If the eigenfrequency of the stand matches the movement frequency of the robot arm, the entire system can resonate, creating the impression that the robot arm is vibrating. Lack of dynamic stiffness can also result in protective stops. The stand should have a minimum resonance frequency of 45 Hz.
- **Fatigue:** The stand shall be dimensioned to match the expected operating lifetime and load cycles of the complete system.



CAUTION

- If the robot is mounted on an external axis, the accelerations of this axis must not be too high. You can let the robot software compensate for the acceleration of external axes by using the script command `set_base_acceleration()`
- High accelerations might cause the robot to make safety stops.



WARNING

- Potential for tip-over Hazards.
- The robot arm's operational loads may cause movable platforms, such as tables or mobile robots, to tip over, resulting in possible accidents.
- Prioritize safety by implementing adequate measures to prevent the tipping of movable platforms at all times.

3.4. Securing Tool

Description

The tool or workpiece is mounted to the tool output flange (ISO 9409-1) at the tip of the robot.

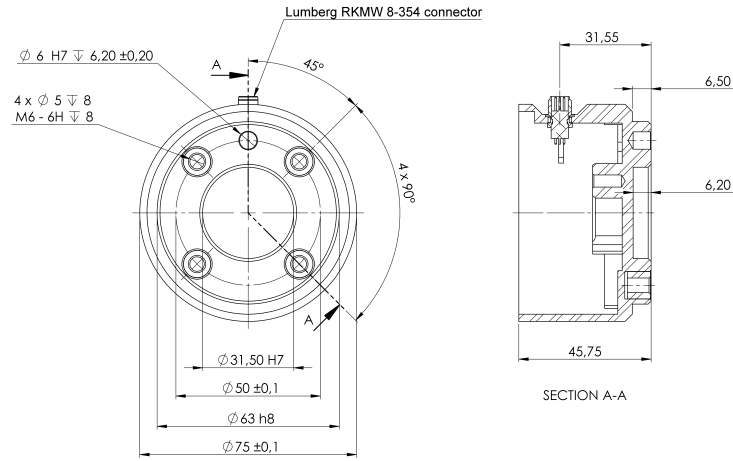

2.3: Dimensions and hole pattern of the tool. All measurements are in millimeters.

Tool flange

The tool output flange (ISO 9409-1) is where the tool is mounted at the tip of the robot. It is recommended to use a radially slotted hole for the positioning pin to avoid over-constraining, while keeping precise position.



CAUTION

Very long M8 bolts can press against the bottom of the tool flange and short circuit the robot.

- Do not use bolts that extend beyond 10 mm to mount the tool.



WARNING

Failure to tighten bolts properly cause injury due to loss of the adapter flange and/or end effector.

- Ensure the tool is properly and securely bolted in place.
- Ensure the tool is constructed such that it cannot create a hazardous situation by dropping a part unexpectedly.

Copyright © 2009-2024 by Universal Robots A/S. All rights reserved.

3.5. Control Box Clearance

Description

The flow of hot air in the Control Box can result in equipment malfunction. The Control Box requires a minimum clearance of 50 mm on each side for sufficient cool airflow. The recommended Control Box clearance is 200 mm.

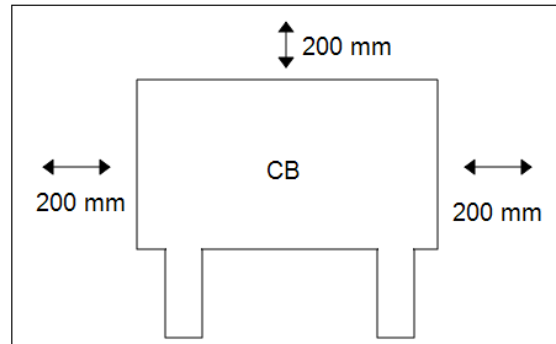
**WARNING**

A wet Control Box can cause fatal injury.

- Make sure the Control Box and cables do not come into contact with liquids.
- Place the Control Box (IP44) in an environment suited for the IP rating.

3.6. Maximum Payload

Description

The rated payload of the Robot Arm depends on the *center of gravity offset* of the payload, see [Figure 3 Mechanical Interface on page 36](#)

The center of gravity offset is defined as the distance from the center of the tool flange to the center of gravity of the attached payload.

When computing the payload mass in a pick and place application, for example, consider both the gripper and object handled by the gripper.

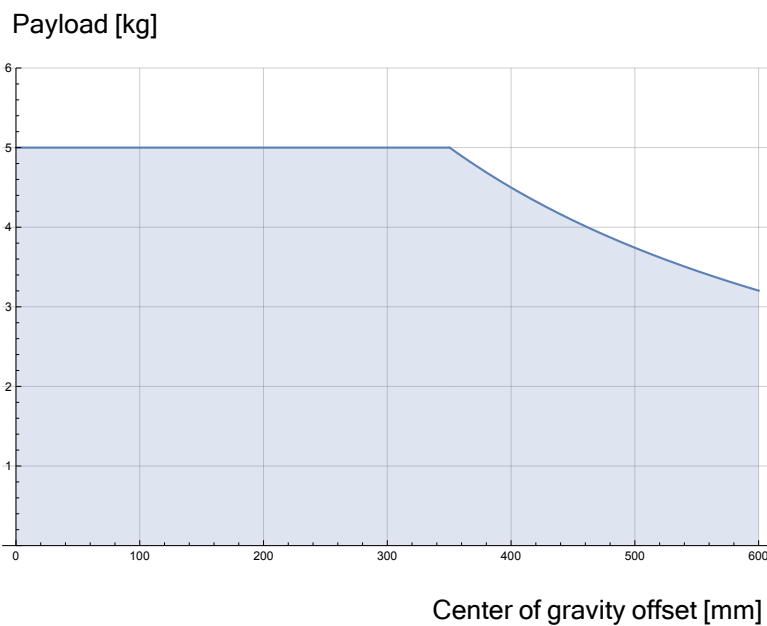

2.4: The relationship between the rated payload and the center of gravity offset.

Payload Inertia

The robot can be used with high inertia payloads. The control software automatically adjusts accelerations, if you correctly enter the following in PolyScope (see: [Set Payload](#)):

- Payload mass
- Center of gravity
- Inertia

You can use the URSim to evaluate the accelerations and cycle times of the robot motions with a specific payload.

4. Electrical Interface

Description

The robot arm and the Control Box contain electrical interface groups. Examples are given for most types of I/O. The term I/O refers to both digital and analog control signals to or from the electrical interface groups listed below.

- Mains connection
- Robot connection
- Controller I/O
- Tool I/O
- Ethernet

All voltages and currents are in Direct Current (DC) unless otherwise specified.

4.1. Electrical Warnings and Cautions

Warnings

Observe the following warnings for all the interface groups, including when you design and install an application.



WARNING

Failure to follow any of the below can result in serious injury or death, as the safety functions could be overridden.

- Never connect safety signals to a PLC that is not a safety PLC with the correct safety level. It is important to keep safety interface signals separated from the normal I/O interface signals.
- All safety-related signals shall be constructed redundantly (two independent channels).
- Keep the two independent channels separate so a single fault cannot lead to loss of the safety function.



WARNING: ELECTRICITY

Failure to follow any of the below can result in serious injury or death due to electrical hazards.

- Make sure all equipment not rated for water exposure remain dry. If water is allowed to enter the product, lockout-tagout all power and then contact your local Universal Robots service provider for assistance.
- Only use the original cables supplied with the robot only. Do not use the robot for applications where the cables are subject to flexing.
- Use caution when installing interface cables to the robot I/O. The metal plate in the bottom is intended for interface cables and connectors. Remove the plate before drilling holes. Make sure that all shavings are removed before reinstalling the plate. Remember to use correct gland sizes.



CAUTION

Disturbing signals with levels higher than those defined in the specific IEC standards can cause unexpected behaviors from the robot. Be aware of the following:

- The robot has been tested according to international IEC standards for **ElectroMagnetic Compatibility (EMC)**. Very high signal levels or excessive exposure can damage the robot permanently. EMC problems are found to happen usually in welding processes and are normally prompted by error messages in the log. Universal Robots cannot be held responsible for any damages caused by EMC problems.
- I/O cables going from the Control Box to other machinery and factory equipment may not be longer than 30m, unless additional tests are performed.



GROUND

Negative connections are referred to as Ground (GND) and are connected to the casing of the robot and the Control Box. All mentioned GND connections are only for powering and signalling. For PE (Protective Earth) use the M6-size screw connections marked with earth symbols inside the Control Box. The grounding conductor shall have at least the current rating of the highest current in the system.



READ MANUAL

Some I/Os inside the Control Box can be configured for either normal or safety-related I/O. Read and understand the complete Electrical Interface chapter.

4.2. Controller I/O

Description

You can use the I/O inside the Control Box for a wide range of equipment including pneumatic relays, PLCs and emergency stop buttons. The illustration below shows the layout of electrical interface groups inside the Control Box.

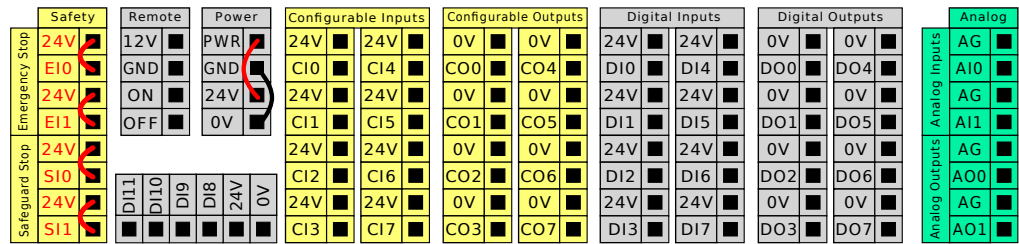

You can use the horizontal Digital Inputs block (DI8-DI11), illustrated below, for quadrature encoding Conveyor Tracking.

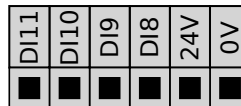

The meaning of the color schemes listed below must be observed and maintained.

Yellow with red text	Dedicated safety signals
Yellow with black text	Configurable for safety
Gray with black text	General purpose digital I/O
Green with black text	General purpose analog I/O

In the GUI, you can set up **configurable I/O** as either **safety-related I/O** or **general purpose I/O**.

Common specifications for all digital I/O

This section defines electrical specifications for the following 24V digital I/O of the Control Box.

- Safety I/O.
- Configurable I/O.
- General purpose I/O.



NOTICE

The word **configurable** is used for I/O configured as either safety-related I/O or normal I/O. These are the yellow terminals with black text.

Install the robot according to the electrical specifications which are the same for all three inputs.

It is possible to power the digital I/O from an internal 24V power supply or from an external power source by configuring the terminal block called **Power**. This block consists of four terminals. The upper two (PWR and GND) are 24V and ground from the internal 24V supply. The lower two terminals (24V and 0V) in the block are the 24V input to supply the I/O. The default configuration uses the internal power supply.

Power supply

If more current is needed, connect an external power supply as shown below.

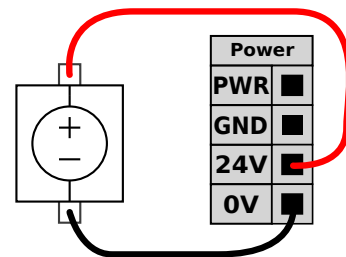
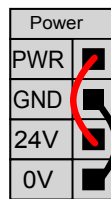

In this example the default configuration using the internal power supply

In this example the default configuration with an external power supply for more current.

The electrical specifications for both the internal and external power supply are shown below.

Terminals	Parameter	Min	Typ	Max	Unit
<i>Internal 24V power supply</i>					
[PWR - GND]	Voltage	23	24	25	V
[PWR - GND]	Current	0	-	2*	A
<i>External 24V input requirements</i>					
[24V - 0V]	Voltage	20	24	29	V
[24V - 0V]	Current	0	-	6	A

*3.5A for 500ms or 33% duty cycle.

Digital I/Os

The digital I/O are constructed in compliance with IEC 61131-2. The electrical specifications are shown below.

Terminals	Parameter	Min	Typ	Max	Unit
<i>Digital Outputs</i>					
[CO _x / DO _x]	Current*	0	-	1	A
[CO _x / DO _x]	Voltage drop	0	-	0.5	V
[CO _x / DO _x]	Leakage current	0	-	0.1	mA
[CO _x / DO _x]	Function	-	PNP	-	Type
[CO _x / DO _x]	IEC 61131-2	-	1A	-	Type
<i>Digital Inputs</i>					
[EI _x /SI _x /CI _x /DI _x]	Voltage	-3	-	30	V
[EI _x /SI _x /CI _x /DI _x]	OFF region	-3	-	5	V
[EI _x /SI _x /CI _x /DI _x]	ON region	11	-	30	V
[EI _x /SI _x /CI _x /DI _x]	Current (11-30V)	2	-	15	mA
[EI _x /SI _x /CI _x /DI _x]	Function	-	PNP +	-	Type
[EI _x /SI _x /CI _x /DI _x]	IEC 61131-2	-	3	-	Type

*For resistive loads or inductive loads of maximum 1H.

4.3. Safety I/O

Safety I/O

This section describes dedicated safety input (Yellow terminal with red text) and configurable I/O (Yellow terminals with black text) when configured as safety I/O. Safety devices and equipment must be installed according to the safety instructions and the risk assessment in chapter Safety.

All safety I/O are paired (redundant), so a single fault does not cause loss of the safety function. However, the safety I/O must be kept as two separate branches.

The permanent safety input types are:

- **Robot Emergency Stop** for emergency stop equipment only
- **Safeguard Stop** for protective devices
- **3PE Stop** for protective devices

Table The functional difference is shown below.

	Emergency Stop	Safeguard Stop	3PE Stop
Robot stops moving	Yes	Yes	Yes
Program execution	Pauses	Pauses	Pauses
Drive power	Off	On	On
Reset	Manual	Automatic or manual	Automatic or manual
Frequency of use	Infrequent	Every cycle to infrequent	Every cycle to infrequent
Requires re-initialization	Brake release only	No	No
Stop Category (IEC 60204-1)	1	2	2
Performance level of monitoring function (ISO 13849-1)	PLd	PLd	PLd

Safety caution Use the configurable I/O to set up additional safety I/O functionality, e.g. Emergency Stop Output. Use the PolyScope interface to define a set of configurable I/O for safety functions.



CAUTION

Failure to verify and test the safety functions regularly can lead to hazardous situations.

- Safety functions shall be verified before putting the robot into operation.
- Safety functions shall be tested regularly.

OSSD signals All configured and permanent safety inputs are filtered to allow the use of OSSD safety equipment with pulse lengths under 3ms. The safety input is sampled every millisecond and the state of the input is determined by the most frequently seen input signal over the last 7 milliseconds.

OSSD Safety Signals

You can configure the Control Box to output OSSD pulses when a safety output is inactive/high. OSSD pulses detect the ability of the Control Box to make safety outputs active/low. When OSSD pulses are enabled for an output, a 1ms low pulse is generated on the safety output once every 32ms. The safety system detects when an output is connected to a supply and shuts down the robot.

The illustration below shows: the time between pulses on a channel (32ms), the pulse length (1ms) and the time from a pulse on one channel to a pulse on the other channel (18ms)

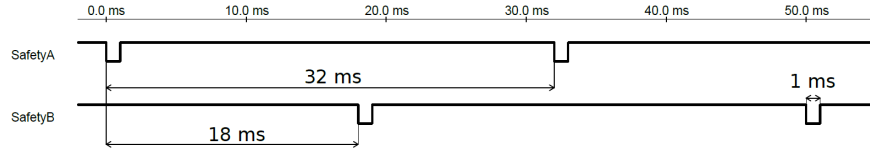

To enable OSSD for Safety Output

1. In the Header, tap **Installation** and select **Safety**.
2. Under **Safety**, select **I/O**.
3. On the I/O screen, under Output Signal, select the desired OSSD checkbox. You must assign the output signal to enable the OSSD checkboxes.

Default safety configuration

The robot is delivered with a default configuration, which enables operation without any additional safety equipment.

		Safety
Emergency Stop	24V	<input checked="" type="checkbox"/>
	E10	<input checked="" type="checkbox"/>
Safeguard Stop	24V	<input checked="" type="checkbox"/>
	E11	<input checked="" type="checkbox"/>
	S10	<input checked="" type="checkbox"/>
	24V	<input checked="" type="checkbox"/>
	S11	<input checked="" type="checkbox"/>

Connecting emergency stop buttons

Most applications require one or more extra emergency stop buttons. The illustration below shows how one or more emergency stop buttons can be connected.

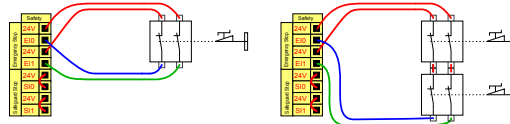

Sharing the Emergency Stop with other machines

You can set up a shared emergency stop function between the robot and other machines by configuring the following I/O functions via the GUI. The Robot Emergency Stop Input cannot be used for sharing purposes. If more than two UR robots or other machines need to be connected, a safety PLC must be used to control the emergency stop signals.

- Configurable input pair: External emergency stop.
- Configurable output pair: System emergency stop.

The illustration below shows how two UR robots share their emergency stop functions. In this example the configured I/Os used are CI0-CI1 and CO0-CO1.

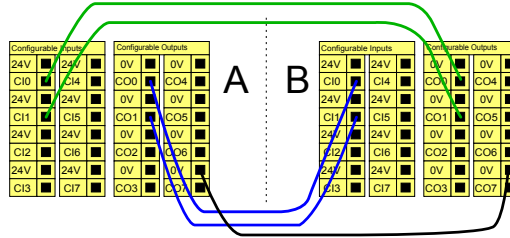

Safeguard stop with automatic resume

This configuration is only intended for applications where the operator cannot go through the door and close it behind him. The configurable I/O is used to setup a reset button outside the door to reactivate robot motion. The robot resumes movement automatically when the signal is re-established.



WARNING

Do not use this configuration if signal can be re-established from the inside of the safety perimeter.

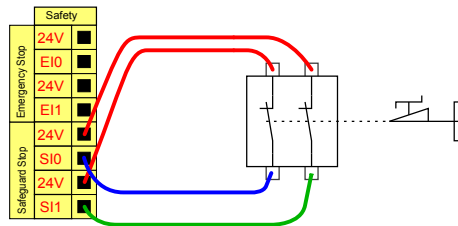

In this example a door switch is a basic safeguard device where the robot is stopped when the door is opened.

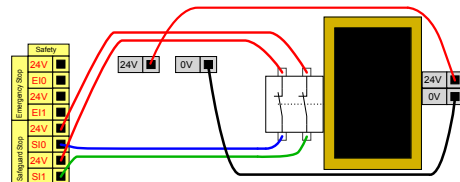

In this example a safety mat is a safety device where automatic resume is appropriate. This example is also valid for a safety laser scanner.

Safeguard Stop with reset button

If the safeguard interface is used to interact with a light curtain, a reset outside the safety perimeter is required. The reset button must be a two channel type. In this example the I/O configured for reset is C10-C11.

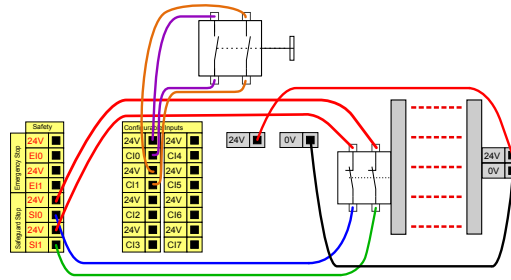

final

4.4. Three Position Enabling Device

Description

The robot arm is equipped with an enabling device in the form of the 3PE Teach Pendant.

The Control Box supports the following enabling device configurations:

- 3PE Teach Pendant
- External Three-Position Enabling device
- External Three-Position device and 3PE Teach Pendant

The illustration below shows how to connect a Three-Position Enabling device.

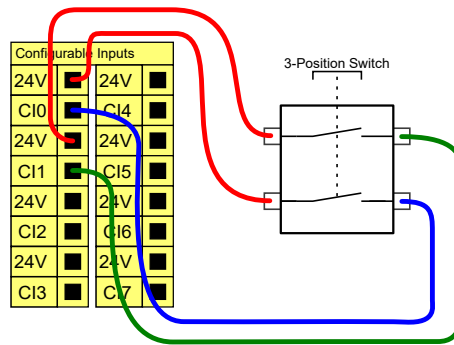

Note: The two input channels for the Three-Position Enabling Device input have a disagreement tolerance of 1 second.



NOTICE

The UR robot safety system does not support multiple external Three-Position Enabling Devices.

Operational Mode Switch

Using a Three-Position Enabling device requires the use of an Operational Mode switch.

The illustration below shows an Operational Mode switch.

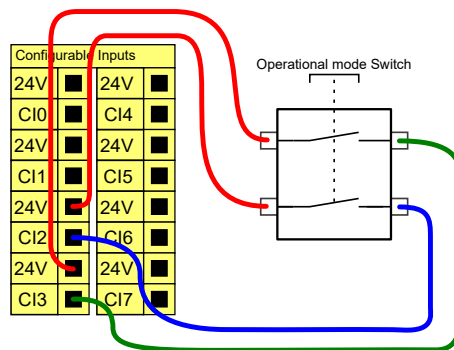

4.5. General Purpose Digital I/O

Description The Startup screen contains settings for automatically loading and starting a default program, and for auto-initializing the Robot arm during power up.

General purpose digital I/O This section describes the general purpose 24V I/O (Gray terminals) and the configurable I/O (Yellow terminals with black text) when not configured as safety I/O.

The general purpose I/O can be used to drive equipment like pneumatic relays directly or for communication with other PLC systems. All Digital Outputs can be disabled automatically when program execution is stopped.

In this mode, the output is always low when a program is not running. Examples are shown in the following subsections.

These examples use regular Digital Outputs but any configurable outputs could also have be used if they are not configured to perform a safety function.

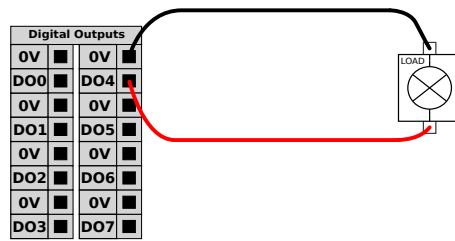

In this example a load is controlled from a Digital Outputs when connected.

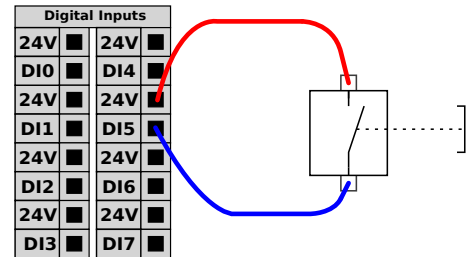

In this example a simple button is connected to a Digital Input.

Communication with other machines or PLCs You can use the digital I/O to communicate with other equipment if a common GND (0V) is established and if the machine uses PNP technology, see below.

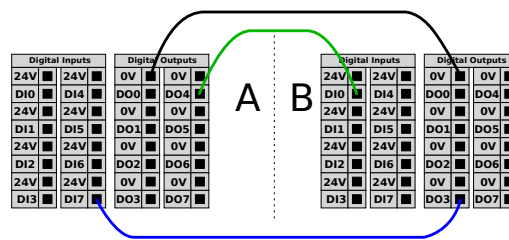

Copyright © 2009-2024 by Universal Robots A/S. All rights reserved.

4.6. General Purpose Analog I/O

Description

The analog I/O interface is the green terminal. It is used to set or measure voltage (0-10V) or current (4-20mA) to and from other equipment.

The following directions is recommended to achieve the highest accuracy.

- Use the AG terminal closest to the I/O. The pair share a common mode filter.
- Use the same GND (0V) for equipment and Control Box. The analog I/O is not galvanically isolated from the Control Box.
- Use a shielded cable or twisted pairs. Connect the shield to the GND terminal at the terminal called **Power**.
- Use equipment that works in current mode. Current signals are less sensitive to interferences.

Electrical Specifications

In the GUI you can select input modes. The electrical specifications are shown below.

Terminals	Parameter	Min	Typ	Max	Unit
<i>Analog Input in current mode</i>					
[AIx - AG]	Current	4	-	20	mA
[AIx - AG]	Resistance	-	20	-	ohm
[AIx - AG]	Resolution	-	12	-	bit
<i>Analog Input in voltage mode</i>					
[AIx - AG]	Voltage	0	-	10	V
[AIx - AG]	Resistance	-	10	-	Kohm
[AIx - AG]	Resolution	-	12	-	bit
<i>Analog Output in current mode</i>					
[AOx - AG]	Current	4	-	20	mA
[AOx - AG]	Voltage	0	-	24	V
[AOx - AG]	Resolution	-	12	-	bit
<i>Analog Output in voltage mode</i>					
[AOx - AG]	Voltage	0	-	10	V
[AOx - AG]	Current	-20	-	20	mA
[AOx - AG]	Resistance	-	1	-	ohm
[AOx - AG]	Resolution	-	12	-	bit

Analog Output and Analog Input

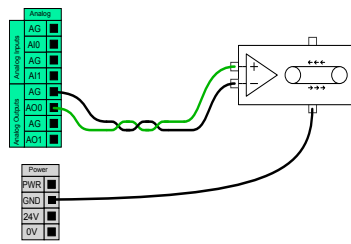

This example illustrates controlling a conveyor belt with an analog speed control input.

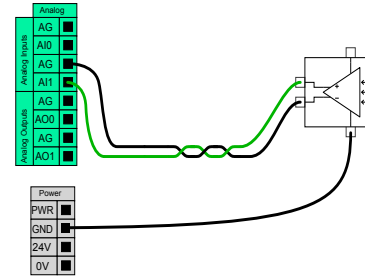

This example illustrates connecting an analog sensor.

4.7. Remote ON/OFF Control

Description

Use remote **ON/OFF** control to turn the Control Box on and off without using the Teach Pendant. It is typically used:

- When the Teach Pendant is inaccessible.
- When a PLC system must have full control.
- When several robots must be turned on or off at the same time.

Remote Control

The remote **ON/OFF** control provides a auxiliary 12V supply, kept active when the Control Box is turned off. The **ON** input is intended only for short time activation and works in the same way as the **POWER** button. The **OFF** input can be held down as desired. Use a software feature to load and start programs automatically (see part [Part II PolyScope Manual](#)).

The electrical specifications are shown below.

Terminals	Parameter	Min	Typ	Max	Unit
[12V - GND]	Voltage	10	12	13	V
[12V - GND]	Current	-	-	100	mA
[ON / OFF]	Inactive voltage	0	-	0.5	V
[ON / OFF]	Active voltage	5	-	12	V
[ON / OFF]	Input current	-	1	-	mA
[ON]	Activation time	200	-	600	ms

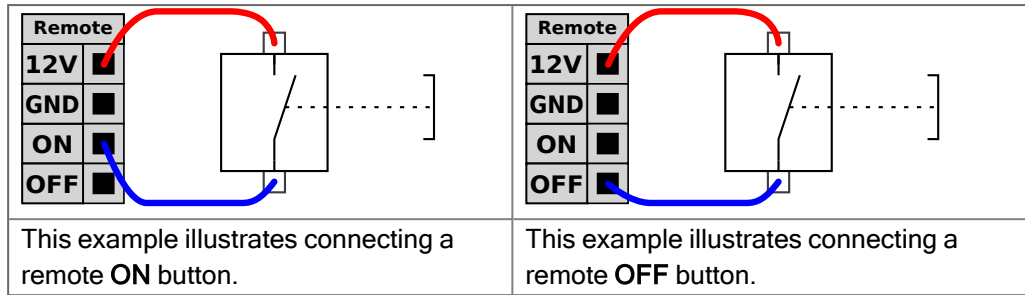

CAUTION

Maintaining a press and hold on the power button switches the Control Box OFF without saving.

- Do not press and hold the **ON** input or the **POWER** button without saving.
- Use the **OFF** input for remote off control to allow the Control Box to save open files and shut down correctly.

4.8. Control Box Connection Ports

Description

The underside of the I/O interface groups is equipped with external connection ports, as illustrated below. There are capped openings at the base of the Control Box cabinet to run external connector cables to access the ports.

External connection ports

The Mini Displayport supports monitors using Displayport. This requires an active Mini Display to DVI or HDMI converter. Passive converters do not work with DVI/HDMI ports. The Fuse must be a UL marked, Mini Blade type with maximum current rating: 10A and minimum voltage rating: 32V

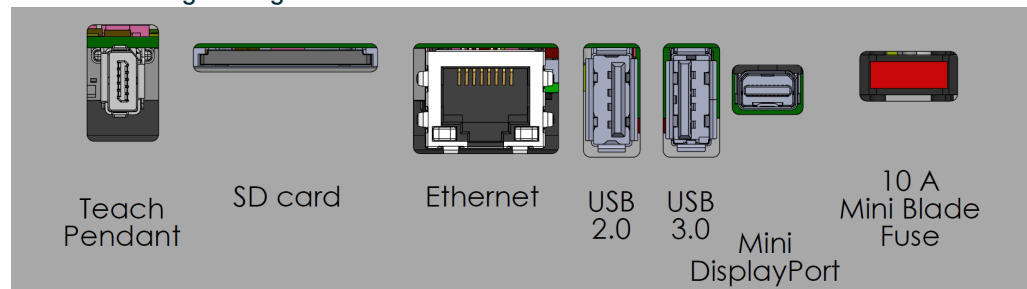

NOTICE

Connecting or disconnecting a Teach Pendant while the Control Box is powered on can cause damage.

- Do not connect a Teach Pendant while the Control Box is on.
- Power off the Control Box before you connect a Teach Pendant.

Do not connect or disconnect the Teach Pendant while Control Box is powered on. This can cause damage to Control Box.



NOTICE

Failure to plug in the active adapter before powering on the Control Box can hinder the display output.

- Plug in the active adapter before powering on the Control Box.
- In some cases the external monitor must be powered on before the Control Box.
- Use an active adapter that supports revision 1.2 as not all adapters function out-of-the-box.

4.9. Ethernet

- Description** The Ethernet interface can be used for:
- MODBUS, EtherNet/IP and PROFINET.
 - Remote access and control.

To connect the Ethernet cable by passing it through the hole at the base of the Control Box, and plugging it into the Ethernet port on the underside of the bracket. Replace the cap at the base of the Control Box with an appropriate cable gland to connect the cable to the Ethernet port.

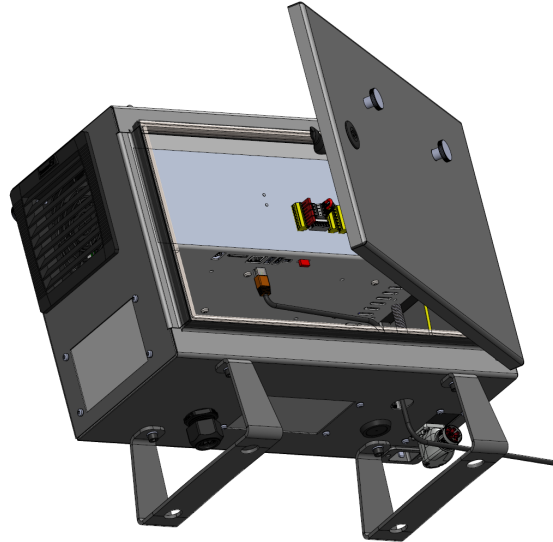

The electrical specifications are shown in the table below.

Parameter	Min	Typ	Max	Unit
Communication speed	10	-	1000	Mb/s

Copyright © 2009-2024 by Universal Robots A/S. All rights reserved.

4.10. Mains Connections

- Description** The mains cable from the Control Box has a standard IEC plug at the end. Connect a country specific mains plug, or cable, to the IEC plug.



NOTICE

- IEC 61000-6-4:Chapter 1 scope: “This part of IEC 61000 for emission requirement applies to electrical and electronic equipment intended for use within the environment of existing at industrial (3.1.12) locations.”
- IEC 61000-6-4:Chapter 3.1.12 industrial location: “Locations characterized by a separate power network, supplied from a high- or medium-voltage transformer, dedicated for the supply of the installation”

Mains connections

To power the robot, the Control Box shall be connected to the mains via the supplied power cord. The IEC C13 connector on the power cord connects to the IEC C14 appliance inlet at the bottom of the Control Box.



NOTICE

Always use a power cord with a country specific wall plug when connecting to the Control Box. Do not use an adapter.

As a part of the electrical installation, provide the following:

- Connection to ground
- Main fuse
- Residual current device
- A lockable (in the OFF position) switch

A main switch shall be installed to power off all equipment in the robot application as an easy means for lockout. The electrical specifications are shown in the table below.

Parameter	Min	Typ	Max	Unit
Input voltage	90	-	264	VAC
External mains fuse (90-200V)	8 8 15 151515	-	16	A
External mains fuse (200-264V)	8	-	16	A
Input frequency	47	-	440	Hz
Stand-by power	-	-	<1.5	W
Nominal operating power	90	150 150 250250300300	325 325 500500750750	W



WARNING: ELECTRICITY

Failure to follow any of the below can result in serious injury or death due to electrical hazards.

- Ensure the robot is grounded correctly (electrical connection to ground). Use the unused bolts associated with grounding symbols inside the Control Box to create common grounding of all equipment in the system. The grounding conductor shall have at least the current rating of the highest current in the system.
- Ensure the input power to the Control Box is protected with a Residual Current Device (RCD) and a correct fuse.
- Lockout all power for the complete robot installation during service.
- Ensure other equipment shall not supply power to the robot I/O when the robot is locked out.
- Ensure all cables are connected correctly before the Control Box is powered. Always use the original power cord.

4.11. Robot Connections: Robot Cable

Description

This subsection describes the connection for a robot arm configured with a fixed 6 meter Robot Cable.

To connect the arm and Control box

You can turn the connector to the right to make it easier to lock after the cable is plugged in.

- Establish the robot connection by connecting the robot arm to the Control Box with the Robot Cable.
- Plug and lock the cable from the robot into the connector at the bottom of the Control Box shown below.
- Twist the connector twice to ensure it is properly locked before turning on the robot arm.

**CAUTION**

Improper robot connection can result in loss of power to the robot arm.

- Do not disconnect the Robot Cable when the robot arm is turned on.
- Do not extend or modify the original Robot Cable.

4.12. Robot Connections: Base Flange Cable

Description This subsection describes the connection for a robot arm configured with a Base Flange Cable connector.

Base Flange Cable connector The Base Flange Cable connector establishes the robot connection by connecting the robot arm to the Control Box. The Robot Cable connects to the Base Flange Cable connector on one end, and to the Control Box connector on the other end. You can lock each connector when robot connection is established.



CAUTION

The maximum robot connection from the robot arm to the Control Box is 6 m. Improper robot connection can result in loss of power to the robot arm.

- Do not extend a 6 m Robot Cable.



NOTICE

Connecting the Base Flange Cable directly to any Control Box can result in equipment or property damage.

- Do not connect the Base Flange Cable directly to the Control Box.

4.13. Tool I/O

Description

Adjacent to the tool flange on Wrist #3, there is an eight-pinned connector that provides power and control signals for different grippers and sensors that can be attached to the robot. The Lumberg RKMV 8-354 is a suitable industrial cable. Each of the eight wires inside the cable have different colors representing different functions.

This connector provides power and control signals for grippers and sensors used on a specific robot tool. The industrial cable listed below is suitable:

- Lumberg RKMV 8-354.



NOTICE

The Tool Connector must be manually tightened up to a maximum of 0.4Nm.

The eight wires inside the cable have different colors that designate different functions. See table below:

Color	Signal	Description
Red	GND	Ground
Gray	POWER	0V/12V/24V
Blue	TO0/PWR	Digital Outputs 0 or 0V/12V/24V
Pink	TO1/GND	Digital Outputs 1 or Ground
Yellow	TI0	Digital Inputs 0
Green	TI1	Digital Inputs 1
White	AI2 / RS485+	Analog in 2 or RS485+
Brown	AI3 / RS485-	Analog in 3 or RS485-

Access Tool I/O in the Installation Tab (see part [Part II PolyScope Manual](#)) to set the internal power supply to 0V, 12V or 24V. The electrical specifications are shown below:

Parameter	Min	Typ	Max	Unit
Supply voltage in 24V mode	23.5	24	24.8	V
Supply voltage in 12V mode	11.5	12	12.5	V
Supply current (single pin)*	-	600	2000**	mA
Supply current (dual pin)*	-	600	2000**	mA
Supply capacitive load	-	-	8000***	uF

* It is highly recommended to use a protective diode for inductive loads.

** Peak for max 1 second, duty cycle max: 10%. Average current over 10 seconds must not exceed typical current.

*** When tool power is enabled, a 400 ms soft start time begins allowing a capacitive load of 8000 uF to be connected to the tool power supply at start-up. Hot-plugging the capacitive load is not allowed.



NOTICE

The tool flange is connected to GND (same as the red wire).

4.14. Tool Power Supply

Description Access Tool I/O in the Installation Tab

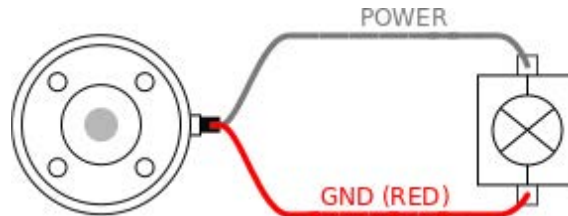

Dual Pin Power Supply

In Dual Pin Power mode, the output current can be increased as listed in Tool I/O.

1. In the Header, tap **Installation**.
2. In the list on the left, tap **General**.
3. Tap **Tool IO** and select **Dual Pin Power**.
4. Connect the wires Power (gray) to TO0 (blue) and Ground (red) to TO1 (pink).

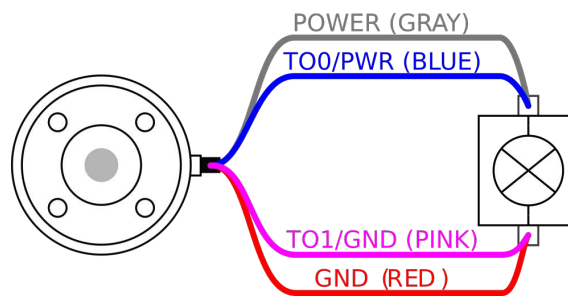

NOTICE

Once the robot makes an Emergency Stop, the voltage is set to 0V for both Power Pins (power is off).

4.15. Tool Digital Outputs

Description

Digital Outputs support three different modes:

Mode	Active	Inactive
Sinking (NPN)	Low	Open
Sourcing (PNP)	High	Open
Push / Pull	High	Low

Access Tool I/O in the Installation Tab to configure the output mode of each pin. The electrical specifications are shown below:

Parameter	Min	Typ	Max	Unit
Voltage when open	-0.5	-	26	V
Voltage when sinking 1A	-	0.08	0.09	V
Current when sourcing/sinking	0	600	1000	mA
Current through GND	0	1000	3000*	mA



NOTICE

Once the robot makes an Emergency Stop, the Digital Outputs (DO0 and DO1) are deactivated (High Z).



CAUTION

The Digital Outputs in the tool are not current-limited. Overriding the specified data can cause permanent damage.

Using Tool Digital Outputs

This example illustrates turning on a load using the internal 12V or 24V power supply. The output voltage at the I/O tab must be define. There is voltage between the POWER connection and the shield/ground, even when the load is turned off.

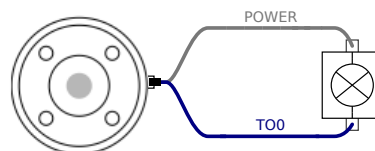

It is recommended to use a protective diode for inductive loads, as shown below.

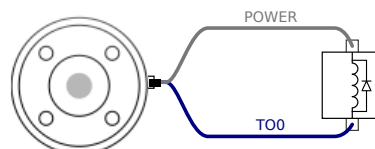

4.16. Tool Digital Inputs

Description

The Startup screen contains settings for automatically loading and starting a default program, and for auto-initializing the Robot arm during power up.

Table

The Digital Inputs are implemented as PNP with weak pull-down resistors. This means that a floating input always reads as low. The electrical specifications are shown below.

Parameter	Min	Type	Max	Unit
Input voltage	-0.5	-	26	V
Logical low voltage	-	-	2.0	V
Logical high voltage	5.5	-	-	V
Input resistance	-	47k	-	Ω

Using the Tool Digital Inputs This example illustrates connecting a simple button.

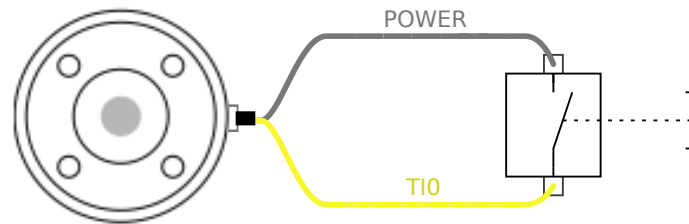

4.17. Tool Analogue Inputs

Description

Tool Analogue Input are non-differential and can be set to either voltage (0-10V) or current (4-20mA) on the I/O tab. The electrical specifications are shown below.

Parameter	Min	Type	Max	Unit
Input voltage in voltage mode	-0.5	-	26	V
Input resistance @ range 0V to 10V	-	10.7	-	k Ω
Resolution	-	12	-	bit
Input voltage in current mode	-0.5	-	5.0	V
Input current in current mode	-2.5	-	25	mA
Input resistance @ range 4mA to 20mA	-	182	188	Ω
Resolution	-	12	-	bit

Two examples of using Analog Input are shown in the following subsections.

Caution



CAUTION

Analog Inputs are not protected against over voltage in current mode. Exceeding the limit in the electrical specification can cause permanent damage to the input.

**Using Tool
Analog Inputs,
Non-differential**

This example shows an analog sensor connection with a non-differential output. The sensor output can be either current or voltage, as long as the input mode of that Analog Input is set to the same on the I/O tab.

Note: You can check that a sensor with voltage output can drive the internal resistance of the tool, or the measurement might be invalid.

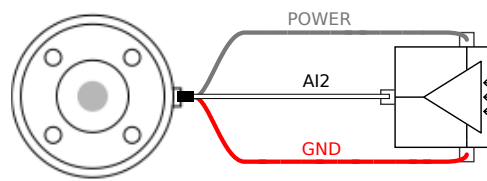

**Using Tool
Analog Inputs,
differential**

This example shows an analog sensor connection with a differential output. Connecting the negative output part to GND (0V), works in the same way as a non-differential sensor.

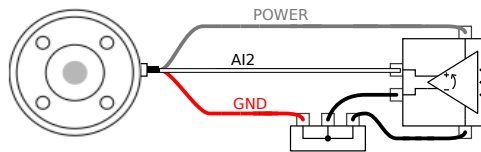

Copyright © 2009-2024 by Universal Robots A/S. All rights reserved.

4.18. Tool Communication I/O

Description

- **Signal requests** The RS485 signals use internal fail-safe biasing. If the attached device does not support this fail-safe, signal biasing must either be done in the attached tool, or added externally by adding pull-up resistors to RS485+ and pull-down to RS485-.
- **Latency** The latency of messages sent via the tool connector ranges from 2ms to 4ms, from the time the message is written on the PC to the start of the message on the RS485. A buffer stores data sent to the tool connector until the line goes idle. Once 1000 bytes of data have been received, the message is written on the device.

Baud Rates	9.6k, 19.2k, 38.4k, 57.6k, 115.2k, 1M, 2M, 5M
Stop Bits	1, 2
Parity	None, Odd, Even

5. Transportation

Description

Only transport the robot in its original packaging. Save the packaging material in a dry place if you want to move the robot later.
When moving the robot from its packaging to the installation space, hold both tubes of the robot arm at the same time. Hold the robot in place until all mounting bolts are securely tightened at the base of the robot.
Lift the Control Box by its handle.



WARNING

Incorrect lifting techniques, or using improper lifting equipment, can lead to injury.

- Avoid overloading your back or other body parts when lifting the equipment.
- Use proper lifting equipment.
- All regional and national lifting guidelines shall be followed.
- Make sure to mount the robot according to the instructions in Mechanical Interface.



NOTICE

If the robot is attached to 3rd-party application / installation during transport, please refer to the following:

- Transporting the robot without its original packaging will void all warranties from Universal Robots A/S.
- If the robot is transported attached to a 3rd-party application / installation, follow the recommendations for transporting the robot without the original transport packaging.

Disclaimer

Universal Robots cannot be held responsible for any damage caused by transportation of the equipment.
You can see the recommendations for transportation without packaging at: universal-robots.com/manuals

5.1. Transport Without Packaging

Description

Universal Robots always recommends transporting the robot in its original packaging. These recommendations are written to reduce unwanted vibrations in joints and brake systems and reduce joint rotation. If the robot is transported without its original packaging, then please refer to the following guidelines:

- Fold the robot as much as possible - do not transport the robot in the singularity position.
- Move the center of gravity in the robot as close to the base as possible.
- Secure each tube to a solid surface on two different points on the tube.
- Secure any attached end effector rigidly in 3 axes.

Transport

Fold the robot as much as possible.

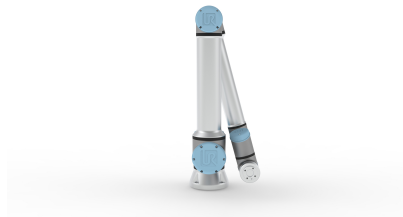

Do not transport extended. (singularity position)

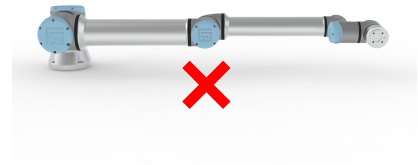
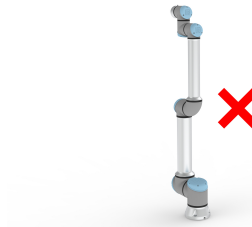

Secure the tubes to a solid surface. Secure attached end effector in 3 axes.

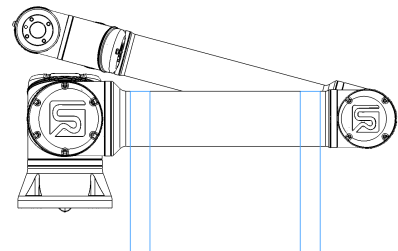
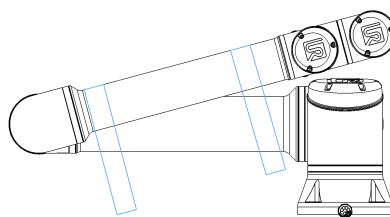

6. Maintenance and Repair

Description

Any maintenance work, inspection and calibration shall be conducted in compliance with all safety instructions in this manual and according to local requirements. Repair work shall be done by Universal Robots. Client designated, trained individuals can do repair work, provided they follow the Service Manual.

Safety for Maintenance

After maintenance and repair work, checks must be done to ensure the required safety level. Checks must adhere to valid national or regional work safety regulations. The correct functioning of all safety functions shall also be tested. The purpose of maintenance and repair work is to ensure that the system is kept operational or, in the event of a fault, to return the system to an operational state. Repair work includes troubleshooting in addition to the actual repair itself. When working on the robot arm or control box, you must observe the procedures and warnings below.

Warning



WARNING

Failure to adhere to any of the safety practices, listed below, can result in injury.

- Unplug the main power cable from the bottom of the Control Box to ensure that it is completely unpowered. Power off any other source of energy connected to the robot arm or Control Box. Take necessary precautions to prevent other persons from powering on the system during the repair period.
- Check the earth connection before re-powering the system.
- Observe ESD regulations when parts of the robot arm or Control Box are disassembled.
- Prevent water and dust from entering the robot arm or Control Box.

Warning: Electricity



WARNING: ELECTRICITY

Disassembling the Control Box power supply too quickly after switching off, can result in injury due to electrical hazards.

- Avoid disassembling the power supply inside the Control Box, as high voltages (up to 600 V) can be present inside these power supplies for several hours after the Control Box has been switched off.

7. Robot Arm Cleaning and Inspection

Description

As part of regular maintenance the robot arm can be cleaned, in accordance with the recommendations in this manual and local requirements.

Cleaning Methods

To address the dust, dirt, or oil on the robot arm and/or Teach Pendant, simply use a cloth alongside one of the cleaning agents provided below.

Surface Preparation: Before applying the below solutions, surfaces may need to be prepared by removing any loose dirt or debris.

Cleaning agents:

- Water
- 70% Isopropyl alcohol
- 10% Ethanol alcohol
- 10% Naphtha (Use to remove grease.)

Application: The solution is typically applied to the surface that needs cleaning using a spray bottle, brush, sponge, or cloth. It can be applied directly or diluted further depending on the level of contamination and the type of surface being cleaned.

Agitation: For stubborn stains or heavily soiled areas, the solution may be agitated using a brush, scrubber, or other mechanical means to help loosen the contaminants.

Dwell Time: If necessary, the solution is allowed to dwell on the surface for a up to 5 minutes to penetrate and dissolve the contaminants effectively.

Rinsing: After the dwell time, the surface is typically rinsed thoroughly with water to remove the dissolved contaminants and any remaining cleaning agent residue. It's essential to ensure thorough rinsing to prevent any residue from causing damage or posing a safety hazard.

Drying: Finally, the cleaned surface may be left to air dry or dried using towels.



WARNING

DO NOT USE BLEACH in any diluted cleaning solution.

**WARNING**

Grease is an irritant and can cause an allergic reaction. Contact, inhalation or ingestion can cause illness or injury. To prevent illness or injury, adhere to the following:

- PREPARATION:
 - Ensure that the area is well ventilated.
 - Have no food or beverages around the robot and cleaning agents.
 - Ensure that an eye wash station is nearby.
 - Gather the required PPE (gloves, eye protection)
- WEAR :
 - Protective gloves: Oil resistant gloves (Nitrile) impermeable and resistant to product.
 - Eye protection is recommended to prevent accidental contact of grease with eyes.
- DO NOT INGEST.
- In the event of
 - contact with skin, wash with water and a mild cleaning agent
 - a skin reaction, get medical attention
 - contact with the eyes, use an eyewash station, get medical attention.
 - inhalation of vapors or ingestion of grease, get medical attention
- After grease work
 - clean contaminated work surfaces.
 - dispose responsibly of any used rags or paper used for cleaning.
- Contact with children and animals is prohibited.

Description**NOTICE**

Using compressed air to clean the robot arm can damage the robot arm components.

- Never use compressed air to clean the robot arm.

Inspection points

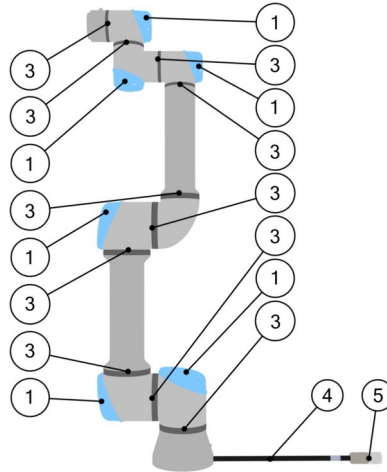

1. Move the robot arm to the Zero position, if possible.
2. Turn off the robot and disconnect the power cable from the Control Box.
3. Inspect the cable between the Control Box and robot arm for any damage.
4. Check the base mounting bolts are properly tightenend.
5. Inspect the flat rings for wear and damage.
 - Replace the flat rings if they are worn or damaged.
6. Inspect the blue lids on all the joints for any cracks or damage.
 - Replace the blue lids if they are cracked or damaged.
7. Inspect the screws used to secure the blue lids.



NOTICE

If any damage is observed on a robot within the warranty period, contact the distributor where the robot was purchased.

Inspection

1. Unmount any tool/s or attachment/s or set the TCP/Payload/CoG according to tool specifications.
2. To move the robot arm in Freedrive:
 - On a 3PE Teach Pendant, rapidly light-press, release, light-press again and keep holding the 3PE button in this position.

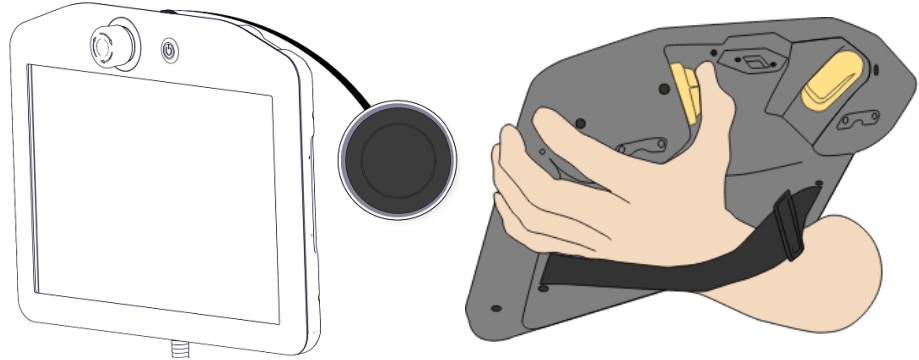

Power button

3PE button

3. Pull/Push the robot to a horizontally elongated position and release.

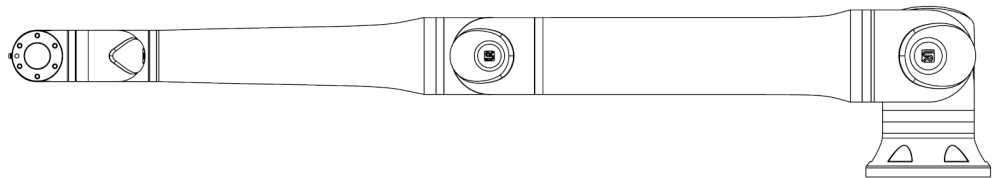

4. Verify the robot arm can maintain the position without support and without activating Freedrive.

8. Disposal and Environment

Description

Universal Robots robots must be disposed of in accordance with the applicable national laws, regulations and standards. This responsibility rests with the owner of the robot.

UR robots are produced in compliance with restricted use of hazardous substances to protect the environment; as defined by the European RoHS directive 2011/65/EU. If robots (robot arm, Control Box, Teach Pendant) are returned to Universal Robots Denmark, then the disposal is arranged by Universal Robots A/S.

The disposal fee for UR robots sold on the Danish market is prepaid to DPA-system by Universal Robots A/S. Importers in countries covered by the European WEEE Directive 2012/19/EU must make their own registration to the national WEEE register of their country. The fee is typically less than 1€/robot.

You can find a list of national registers here: <https://www.ewrn.org/national-registers>.
Search for Global Compliance here: <https://www.universal-robots.com/download>.

Substances in the UR robot**Robot arm**

- Tubes, Base Flange, Tool mounting bracket: Anodized aluminum
- Joint housings: Powder coated aluminum
- Black band sealing rings: AEM rubber
 - additional slip ring under black band: moulded black plastic
- Endcaps/ lids: PC/ASA Plastic
- Minor mechanical components e.g. screws, nuts, spacers (steel, brass, and plastic)
- Wire bundles with copper wires and minor mechanical components e.g. screws, nuts, spacers (steel, brass, and plastic)

Robot arm joints (internal)

- Gears: Steel and grease (detailed in the Service Manual)
- Motors: Iron core with copper wires
- Wire bundles with copper wires, PCB's, various electronic components and minor mechanical components
- Joint seals and O-rings contain a small amount of PFAS which is a compound within PTFE (commonly known as Teflon™).
- Grease: synthetic + mineral oil with a thickener of either lithium complex soap or Urea. Contains molybdenum.
 - Depending on model and date of production, the color of the grease could be yellow, magenta, dark pink, red, green.
 - The Service Manual details the handling precautions and Grease Safety Data Sheets

Control box

- Cabinet (enclosure): Powder coated steel
 - Standard Control Box
 - Aluminum sheet metal housing (internal to the cabinet). This is also the housing of the OEM controller.
 - Standard Control Box and OEM controller.
 - Wire bundles with copper wires, PCB's, various electronic components, plastic connectors, and minor mechanical components e.g. screws, nuts, spacers (steel, brass, and plastic)
 - A lithium battery is mounted to a PCB. See the Service Manual for how to remove.
-

9. Certifications

Description

Third party certification is voluntary. However, to provide the best service to robot integrators, Universal Robots chooses to certify its robots at the recognized test institutes listed below.
 You can find copies of all certificates in the chapter: Certificates.

Certification

 <p>EN ISO 10218-1 EN ISO 13849-1 www.tuv.com ID 0007000000</p>	<p>TÜV Rheinland</p>	<p>Certificates by TÜV Rheinland to EN ISO 10218-1 and EN ISO 13849-1. TÜV Rheinland stands for safety and quality in virtually all areas of business and life. Founded 150 years ago, the company is one of the world's leading testing service providers.</p>
 <p>TÜV Rheinland®</p>	<p>TÜV Rheinland of North America</p>	<p>In Canada, the Canadian Electrical Code, CSA 22.1, Article 2-024 requires equipment to be certified by a testing organization approved by the Standards Council of Canada.</p>
	<p>CHINA RoHS</p>	<p>Universal Robots e-Series robots conform to CHINA RoHS management methods for controlling pollution by electronic information products.</p>
	<p>KCC Safety</p>	<p>Universal Robots e-Series robots have been assessed and conform to KCC mark safety standards.</p>
	<p>KC Registration</p>	<p>The Universal Robots e-Series robots have been evaluated for conformity assessment for use in a work environment. Therefore, there is a risk of radio interference when used in a domestic environment.</p>
	<p>Delta</p>	<p>Universal Robots e-Series robots are performance tested by DELTA.</p>

Supplier Third Party Certification

	<p>Environment</p>	<p>As provided by our suppliers, Universal Robots e-Series robots shipping pallets comply with the ISMPM-15 Danish requirements for producing wood packaging material and are marked in accordance with this scheme.</p>
---	--------------------	--

Manufacturer Test Certification

	Universal Robots	Universal Robots e-Series robots undergo continuous internal testing and end of line test procedures. UR testing processes undergo continuous review and improvement.
---	------------------	---

Declarations according to EU directives

Although EU directives are relevant for Europe, some countries outside Europe recognize and/or require EU declarations. European directives are available on the official homepage: <http://eur-lex.europa.eu>. According to the Machinery Directive, Universal Robots' robots are partly completed machines, as such a CE mark is not to be affixed. You can find the Declaration of Incorporation (DOI) according to the Machinery Directive in the chapter: Declarations and Certificates.

10. Stopping Time and Stopping Distance

Description



NOTICE

You can set user-defined safety rated maximum stopping time and distance.
If user-defined settings are used, the program speed is dynamically adjusted to always comply with the selected limits.

The graphical data provided for **Joint 0 (base)**, **Joint 1 (shoulder)** and **Joint 2 (elbow)** is valid for stopping distance and stopping time:

- Category 0
- Category 1
- Category 2

The **Joint 0** test was carried out using a horizontal movement, where the rotational axis was perpendicular to the ground. For the **Joint 1** and **Joint 2** tests, the robot followed a vertical trajectory, where the rotational axes were parallel to the ground, and the stop was done while the robot was moving downward.
The Y-axis is the distance from where the stop is initiated to the final position.
The payload CoG is at the tool flange.

Joint 0 (BASE)

Stopping distance in meters for 33% of 5kg

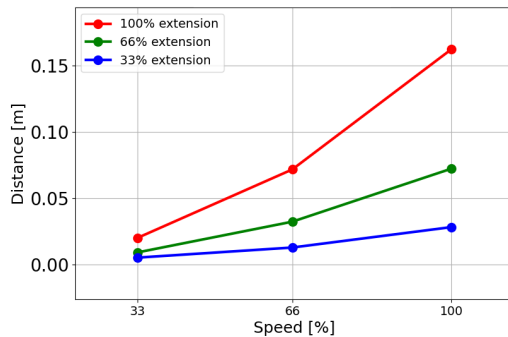

Stopping distance in meters for 66% of 5kg

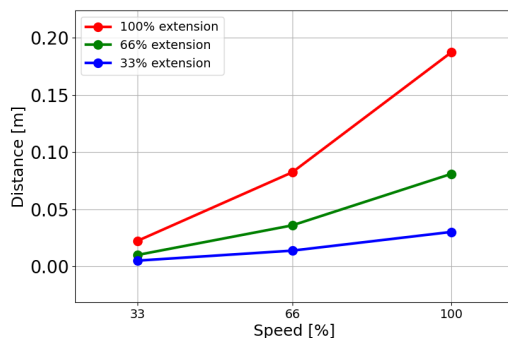

Stopping distance
in meters for
maximum payload
of 5kg

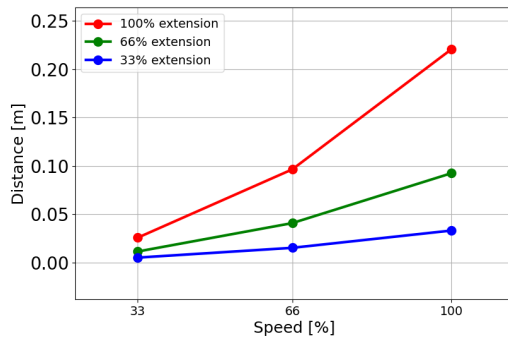

Joint 0 (BASE)

Stopping time in
seconds for 33%
of 5kg

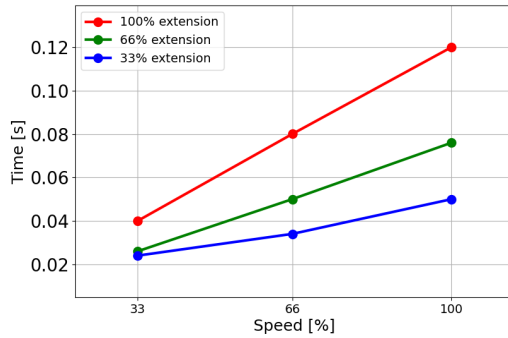

Stopping time
in seconds for 66% of 5kg

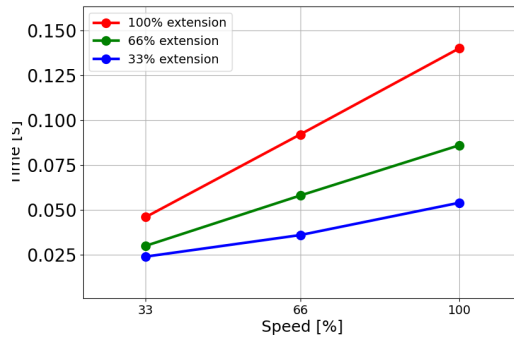

Stopping time in
seconds for
maximum payload
of 5kg

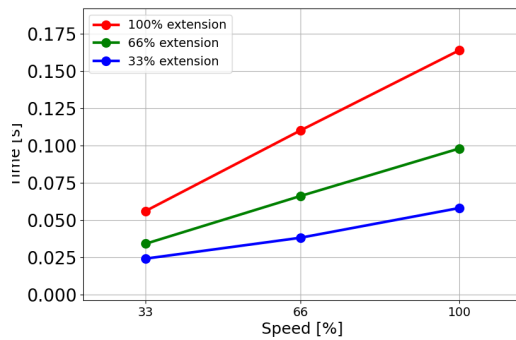

Copyright © 2009-2024 by Universal Robots A/S. All rights reserved.



Joint 1 (SHOULDER)

Stopping distance in meters for 33% of 5kg

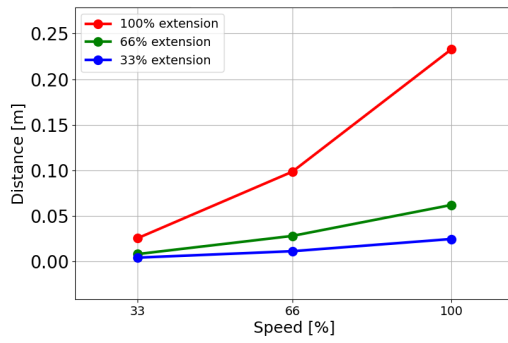

Stopping distance in meters for 66% of 5kg

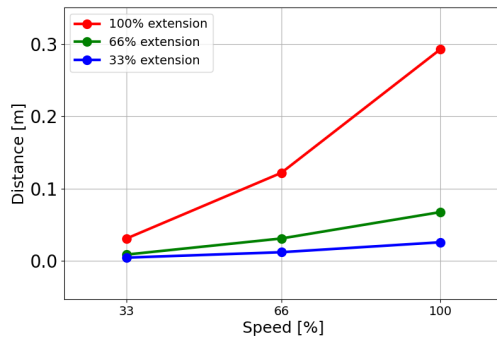

Stopping distance in meters for maximum payload of 5kg

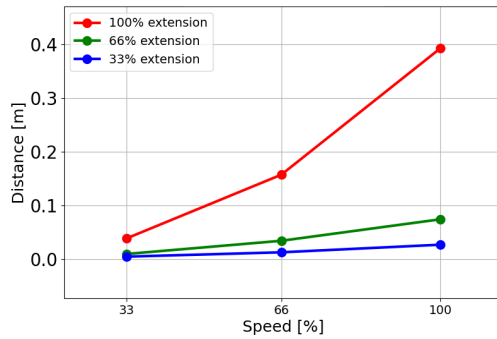

Joint 1 (SHOULDER)

Stopping time in seconds for 33% of 5kg

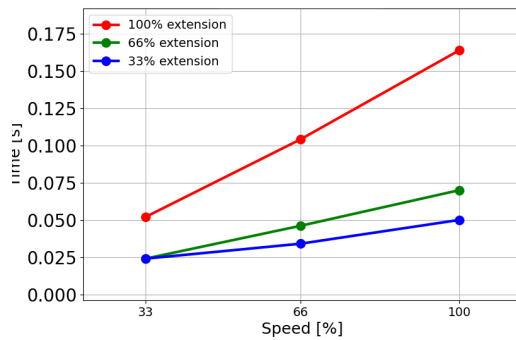

Stopping time in seconds for 66% of 5kg

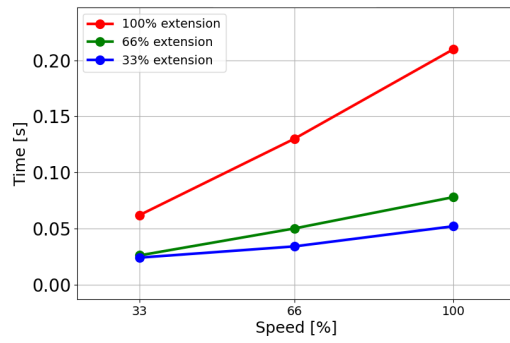

Stopping time in seconds for maximum payload of 5kg

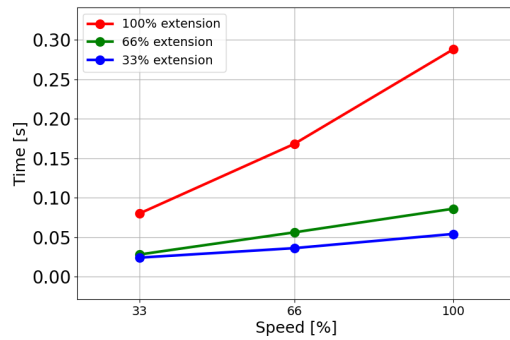

Joint 2 (ELBOW)

Stopping distance in meters for 33% of 5kg

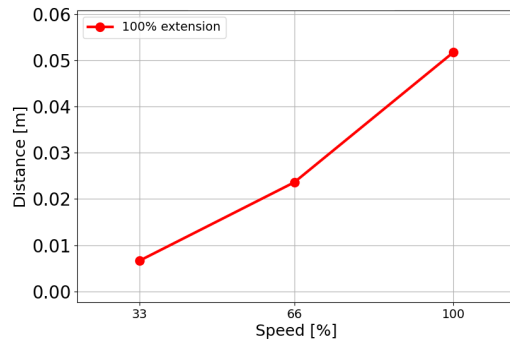

Stopping distance in meters for 66% of 5kg

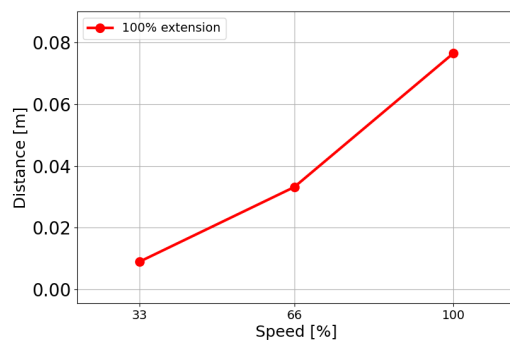

Copyright © 2009-2024 by Universal Robots A/S. All rights reserved.

Stopping distance
in meters
maximum payload
of 5kg

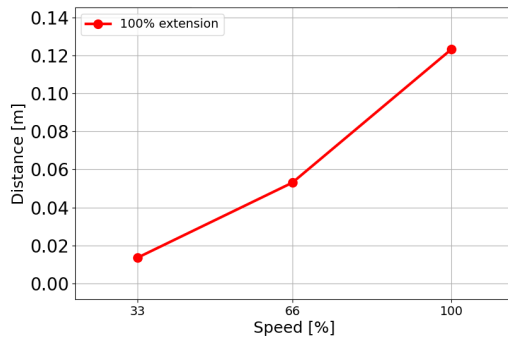

Joint 2 (ELBOW)

Stopping time in
seconds for 33%
of 5kg

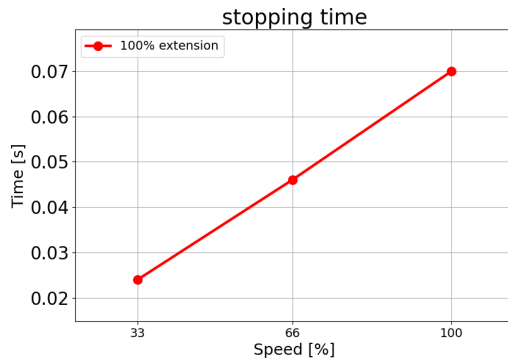

Stopping time in
seconds for 66%
of 5kg

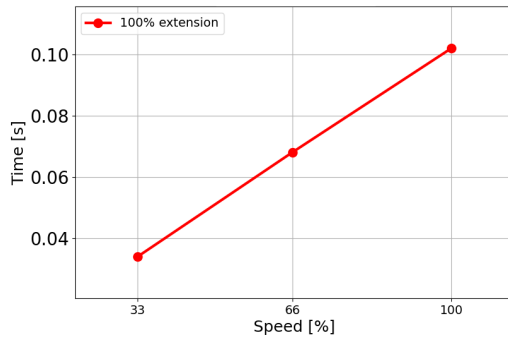

Stopping time in
seconds for
maximum payload
of 5kg

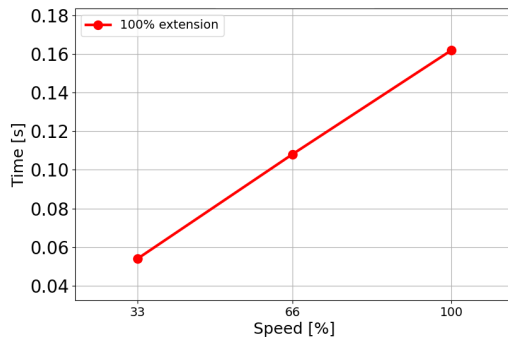

Copyright © 2009-2024 by Universal Robots A/S. All rights reserved.

11. Declarations and Certificates (original EN)

EU Declaration of Incorporation (DOI) (in accordance with 2006/42/EC Annex II B) original EN	
Manufacturer	Universal Robots A/S Energivej 51, DK-5260 Odense S Denmark
Person in the Community Authorized to Compile the Technical File	David Brandt Technology Officer, R&D Universal Robots A/S, Energivej 25, DK-5260 Odense S
Description and Identification of the Partially-Completed Machine(s)	
Product and Function:	Industrial robot multi-purpose multi-axis manipulator with control box & with or without teach pendant Function is determined by the completed machine (robot application or cell with end-effector, intended use and application program).
Model:	UR3e, UR5e, UR10e, UR16e (e-Series): Below cited certifications and this declaration include: <ul style="list-style-type: none"> Effective October 2020: Teach Pendants with 3-Position Enabling (3PE TP) & standard Teach Pendants (TP). Effective May 2021: UR10e specification improvement to 12.5kg maximum payload.
Note: This Declaration of Incorporation is NOT applicable when the UR OEM Controller is used.	
Serial Number:	Starting 20235000000 and higher year e-Series 3=UR3e, 5=UR5e, 3=UR3e, 0=UR10e (10kg), 2=UR10e(12.5), 6=UR16e sequential numbering, restarting at 0 each year
Incorporation:	Universal Robots e-Series (UR3e, UR5e, UR10e and UR16e) shall only be put into service upon being integrated into a final complete machine (robot application or cell), which conforms with the provisions of the Machinery Directive and other applicable Directives.
It is declared that the above products fulfil, for what is supplied, the following directives as detailed below: When this incomplete machine is integrated and becomes a complete machine, the integrator is responsible for determining that completed machine fulfils all applicable Directives and providing the Declaration of Conformity.	
I. Machinery Directive 2006/42/EC II. Low-voltage Directive 2014/35/EU III. EMC Directive 2014/30/EU	The following essential requirements have been fulfilled: 1.1.2, 1.1.3, 1.1.5, 1.2.1, 1.2.4.3, 1.2.5, 1.2.6, 1.3.2, 1.3.4, 1.3.8.1, 1.3.9, 1.5.1, 1.5.2, 1.5.5, 1.5.6, 1.5.10, 1.6.3, 1.7.2, 1.7.4, 4.1.2.3, 4.1.3 Annex VI. It is declared that the relevant technical documentation has been compiled in accordance with Part B of Annex VII of the Machinery Directive. Reference the LVD and the harmonized standards used below. Reference the EMC Directive and the harmonized standards used below.
Reference to the harmonized standards used, as referred to in Article 7(2) of the MD & LV Directives and Article 6 of the EMC Directive:	



(I) EN ISO 10218-1:2011 TÜV Nord Certificate # 44 708 14097607 (I) EN ISO 13732-1:2008 as applicable (I) EN ISO 13849-1:2015 TÜV Nord Certificate # 44 207 14097610 (I) EN ISO 13849-2:2012 (I) EN ISO 13850:2015	(I) (II) EN 60204-1:2018 as applicable (II) EN 60529:1991+A1:2000+A2:2013 (I) EN 60947-5-5:1997+A1:2005 +A11:2013+A2:2017 (I) EN 60947-5-8:2020 (III) EN 61000-3-2:2019	(II) EN 60664-1:2007 (III) EN 61000-3-3:2013 (III) EN 61000-6-1:2019 UR3e & UR5e ONLY (III) EN 61000-6-2:2019 (III) EN 61000-6-3:2007+A1: 2011 UR3e & UR5e ONLY (III) EN 61000-6-4:2019
---	---	---

Reference to other technical standards and technical specifications used:

(I) ISO 9409-1:2004 [Type 50-4-M6] (I) ISO/TS 15066:2016 as applicable (III) EN 60068-2-1: 2007 (III) EN 60068-2-2:2007	(II) EN 60320-1:2021 (III) EN 60068-2-27:2008 (III) EN 60068-2-64:2008+A1:2019	(II) EN 61784-3:2010 [SIL2] (III) EN 61326-3-1: 2017 [Industrial locations SIL 2]
---	--	---

The manufacturer, or his authorised representative, shall transmit relevant information about the partly completed machinery in response to a reasoned request by the national authorities. Approval of full quality assurance system (ISO 9001), by the notified body Bureau Veritas, certificate #DK015892.

Odense Denmark, 10 January 2024

Roberta Nelson Shea, Global Technical Compliance Officer

12. Warranty Information

Content disclaimer

Universal Robots A/S continues to improve the reliability and performance of its products, and as such reserves the right to upgrade products, and product documentation, without prior warning. Universal Robots A/S takes every care to ensure the content of the User Manual/s is precise and correct, but takes no responsibility for any errors or missing information.

This manual does not contain warranty information.

13. Certificates

TÜV Rheinland



TÜV Rheinland North America 

China RoHS 

Copyright © 2009-2024 by Universal Robots A/S. All rights reserved.

KC Safety



KC Registration



Environment 

14. Applied Standards

Description

This section describes relevant standards applied to the development and manufacturing of the UR robot, including the robot arm, Control Box and Teach Pendant .

A standard is not a law, but a document developed by stakeholders within a given industry. Standards contain requirements and guidance for a product or product group.

The abbreviations in this manual and their meaning are listed in the table below:

Abbreviations in this document	
ISO	International Organization for Standardization
IEC	International Electrotechnical Commission
EN	European Norm
TS	Technical Specification
TR	Technical Report
ANSI	American National Standards Institute
RIA	Robotic Industries Association (now known as "A3")
CSA	Canadian Standards Association

Applied Standards

Maintaining robot compliance with the following standards requires adhering to the assembly instructions, safety instructions and guidance in this manual. For the safety of the robot application, the integrator is required to comply with ISO 10218-2. Unauthorized modifications invalidate the Declaration of Incorporation (DOI), certifications and conformity of the robot.

UR robots comply with the relevant requirements in the applied standards. Applicable test reports and certifications included in this manual and the standards are listed in the Declaration of Incorporation.

The standards applicable to this manual are listed in the table below:

**ISO 13849-1
ISO 13849-2**

Clause	Description
Safety of machinery - Safety related parts of control systems Part 1: General principles for design Part 2: Validation	The safety control system is designed according to the requirements of these standards. The Safety Functions are certified to these functional safety standards.

ISO 13850

Clause	Description
Safety of machinery - Emergency stop - Principles for design	---

ISO 12100

Clause	Description
Safety of machinery - General principles for design - Risk assessment and risk reduction	---

ISO 10218-1

Clause	Description
Robots and robotic devices - Safety requirements for industrial robots Part 1: Robots	This standard is intended for the robot manufacturer, not the integrator. ISO 10218-2 has the safety requirements associated with the robot system, application and cell. It deals with the design and integration of the robot application.

**ANSI/RIA
R15.06**

Clause	Description
Industrial Robots and Robot Systems - Safety Requirements	This American national standard is a national adoption without deviation of both ISO 10218-1 and ISO 10218-2, combined into one document. The language is changed from British International English to American English, but the technical contents are the same. Part 2 of this standard is intended for the integrator of the robot system / robot application, and not Universal Robots.



CAN/CSA-Z434

Clause	Description
Industrial Robots and Robot Systems - General Safety Requirements	This Canadian national standard is a national adoption of both ISO 10218-1 and ISO 10218-2 combined into one document. CSA added User to clauses within Part 2. Part 2 of this standard is intended for the integrator of the robot system/ robot application, and not Universal Robots.

CAN/CSA-Z434

Clause	Description
Industrial Robots and Robot Systems - General Safety Requirements	This Canadian national standard is a national adoption of both ISO 10218-1 and ISO 10218-2 combined into one document. CSA added User to clauses within Part 2. Part 2 of this standard is intended for the integrator of the robot system/ robot application, and not Universal Robots.

**IEC
61000-6-2
IEC 61000-6-4**

Clause	Description
Electromagnetic compatibility (EMC) Part 6-2: Generic standards - Immunity for industrial environments Part 6-4: Generic standards - Emission standard for industrial environments	These standards define requirements for the electrical and electromagnetic disturbances. Conforming to these standards ensures that the UR robots perform well in industrial environments and that they do not disturb other equipment.

IEC 61326-3-1

Clause	Description
Electrical equipment for measurement, control and laboratory use - EMC requirements Part 3-1: Immunity requirements for safety-related systems and for equipment intended to perform safety-related functions (functional safety) - General industrial applications	This standard defines extended EMC immunity requirements for safety-related functions. Conforming to this standard ensures that the safety functions perform even if other equipment exceeds the EMC emission limits defined in the IEC 61000 standards.

IEC 61131-2

Clause	Description
Programmable controllers Part 2: Equipment requirements and tests	Both standard and safety-rated 24V I/Os comply with the requirements of this standard to ensure reliable communication with other PLC systems.

Copyright © 2009-2024 by Universal Robots A/S. All rights reserved.

IEC 14118

Clause	Description
Safety of machinery - Prevention of unexpected startup	Safety requirements to prevent an unexpected start and re-start, as a result of power loss or interruption of power.

IEC 60204-1

Clause	Description
Safety of machinery - Electrical equipment of machines Part 1: General requirements	The emergency stop function is designed as a Stop Category 1 according to this standard. Stop Category 1 is a controlled stop with power to the motors to achieve the stop and then removal of power when the stop is achieved.

IEC 60947-5-5

Clause	Description
Low-voltage switchgear and controlgear Part 5-5: Control circuit devices and switching elements - Electrical emergency stop device with mechanical latching function	---

IEC 60529

Clause	Description
Degrees of protection provided by enclosures (IP Code)	This standard defines enclosure ratings regarding protection against dust and water.

IEC 60320-1

Clause	Description
Appliance couplers for household and similar general purposes Part 1: General requirements	The mains input cable complies with this standard.

ISO 9409-1

Clause	Description
Manipulating industrial robots - Mechanical interfaces Part 1: Plates	The tool flange on UR robots conforms to a type according to this standard. Robot tools (end-effectors) should also be constructed according to the same type to ensure proper fitting to the mechanical interface of the specific UR robot.

ISO 13732-1

Clause	Description
Ergonomics of the thermal environment - Methods for the assessment of human responses to contact with surfaces Part 1: Hot surfaces	---

IEC 61140

Clause	Description
Protection against electric shock - Common aspects for installation and equipment	A protective earth/ground connection is mandatory, as defined in the Part I Hardware Installation Manual.

**IEC 60068-2-1
IEC 60068-2-2
IEC 60068-2-27
IEC 60068-2-64**

Clause	Description
Environmental testing Part 2-1: Tests - Test A: Cold Part 2-2: Tests - Test B: Dry heat Part 2-27: Tests - Test Ea and guidance: Shock Part 2-64: Tests - Test Fh: Vibration, broadband random and guidance	---

IEC -61784-3

Clause	Description
Industrial communication networks - Profiles Part 3: Functional safety fieldbuses - General rules and profile definitions	---

IEC 61784-3

Clause	Description
Safety of machinery - Electrical equipment of machines Part 1: General requirements	---

**IEC 60664-1
IEC 60664-5**

Clause	Description
Insulation coordination for equipment within low-voltage systems Part 1: Principles, requirements and tests Part 5: Comprehensive method for determining clearances and creepage distances equal to or less than 2 mm	---

**EUROMAP
67:2015, V1.11**

Clause	Description
Electrical Interface between Injection Molding Machine and Handling Device / Robot	The E67 accessory module, that interfaces with injection molding machines, complies with this standard.

Copyright © 2009-2024 by Universal Robots A/S. All rights reserved.

15. Technical Specifications UR5e

Robot type	UR5e
Robot weight	20.7 kg / 45.7 lb
Maximum payload	5 kg / 11 lb (3 Mechanical Interface on page 36)
Reach	850 mm / 33.5 in
Joint ranges	Unlimited rotation of tool flange, $\pm 360^\circ$ for all other joints $\pm 360^\circ$ for all joints
Speed	Joints: Max 180 °/s . Tool: Approx. 1 m/s / Approx. 39.4 in/s.
System update frequency	500 Hz
Force Torque sensor accuracy	4 N
Pose repeatability	± 0.03 mm / ± 0.0011 in (1.1 mils)per ISO 9283
Footprint	$\varnothing 149$ mm / 5.9 in
Degrees of freedom	6 rotating joints
Control Box size (W × H × D)	460 mm × 449 mm × 254 mm / 18.2 in × 17.6 in × 10 in
Control Box I/O ports	16 digital in, 16 digital out, 2 analog in, 2 analog out
Tool I/O ports	2 digital in, 2 digital out, 2 analog in
Tool Communication	RS
Tool I/O power supply & voltage	12 V/24 V 1.5 A (Dual pin) 1 A (Single pin)
Control Box I/O power supply	24 V 2 A in Control Box
Communication	TCP/IP 1000 Mbit: IEEE 802.3ab, 1000BASE-T Ethernet socket, MODBUS TCP & EtherNet/IP Adapter, Profinet
Programming	PolyScope graphical user interface on 12" touchscreen
Noise	Robot Arm: Less than 60dB(A) Control Box: Less than 50dB(A) Robot Arm: Less than 65dB(A) Control Box: Less than 50dB(A)
IP classification	IP54
Cleanroom classification	Robot Arm: ISO Class 5, Control Box: ISO Class 6
Power consumption (average)	570 W
Power consumption	Approx. 250 W using a typical program
Short-Circuit Current Rating (SCCR)	200A
Collaboration operation	17 advanced safety functions. In compliance with: EN ISO 13849-1, PLd, Cat.3 and EN ISO 10218-1
Materials	Aluminium, PC/ASA plastic
Ambient temperature range	0-50 °C. At ambient temperatures above 35°C, the robot may operate at reduced speed and performance.
Control Box power source	100-240 VAC, 47-440 Hz
TP cable: Teach Pendant to Control Box	4.5 m / 177 in
Robot Cable: Robot Arm to Control Box (options)	Standard (PVC) 6 m/236 in x 13.4 mm Standard (PVC) 12 m/472.4 in x 13.4 mm Hiflex (PUR) 6 m/236 in x 12.1 mm Hiflex (PUR) 12 m/472.4 in x 12.1 mm

16. Safety Functions Table 1

Description

Universal Robots safety functions and safety I/O are PLd Category 3 (ISO 13849-1), where each safety function has a PFH_D value less than 1.8E-07. The PFH_D values are updated to include greater design flexibility for supply chain resilience. For Safety Function (SF) Descriptions see: [16 Safety Functions Table 1 above](#). For safety I/O the resulting safety function including the external device, or equipment, is determined by the overall architecture and the sum of all PFH_Ds, including the UR robot safety function PFH_D.



NOTICE

The Safety Functions tables presented in this chapter are simplified. You can find the comprehensive versions of them here: <https://www.universal-robots.com/support>

SF1 Emergency Stop (according to ISO 13850)

See footnotes

Description	What happens?	Tolerance and PFH _D	Affects
Pressing the Estop PB on the pendant ¹ or the External Estop (if using the Estop Safety Input) results in a Stop Cat 1 ³ with power removed from the robot actuators and the tool I/O. Command ¹ all joints to stop and upon all joints coming to a monitored standstill state, power is removed. For the integrated functional safety rating with an external safety-related control system or an external emergency stop device that is connected to the Emergency Stop input, add the PFH _D of this safety-related input to the PFH _D of this safety function's PFH _D value (less than 1.8E-07).	Category 1 stop (IEC 60204-1)	Tol: -- PFH _D : 1.8E-07	Robot including robot tool I/O

SF2 Safeguard Stop 4 (Robot Stop according to ISO 10218-1)

Description	What happens?	Tolerance and PFH _D	Affects
This safety function is initiated by an external protective device using safety inputs that initiate a Cat 2 stop ³ . The tool I/O are unaffected by the safeguard stop. Various configurations are provided. If an enabling device is connected, it's possible to configure the safeguard stop to function in automatic mode ONLY. See the Stop Time and Stop Distance Safety Functions ⁴ . For the functional safety of the complete integrated safety function, add the PFHd of the external protective device to the PFHd of the Safeguard Stop.	Category 2 stop (IEC 60204-1) SS2 stop (as described in IEC 61800-5-2)	Tol: -- PFH _D : 1.8E-07	Robot

SF3 Joint Position Limit (soft axis limiting)

Description	What happens?	Tolerance and PFH _D	Affects
Sets upper and lower limits for the allowed joint positions. Stopping time and distance is not a considered as the limit(s) will not be violated. Each joint can have its own limits. Directly limits the set of allowed joint positions that the joints can move within. It is set in the safety part of the User Interface. It is a means of safety-rated soft axis limiting and space limiting, according to ISO 10218-1:2011, 5.12.3.	Will not allow motion to exceed any limit settings. Speed could be reduced so motion will not exceed any limit. A robot stop will be initiated to prevent exceeding any limit.	Tol: 5° PFH _D : 1.8E-07	Joint (each)

SF4 Joint Speed Limit

Description	What happens?	Tolerance and PFH _D	Affects
Sets an upper limit for the joint speed. Each joint can have its own limit. This safety function has the most influence on energy transfer upon contact (clamping or transient). Directly limits the set of allowed joint speeds which the joints are allowed to perform. It is set in the safety setup part of the User Interface. Used to limit fast joint movements, e.g. risks related to singularities.	Will not allow motion to exceed any limit settings. Speed could be reduced so motion will not exceed any limit. A robot stop will be initiated to prevent exceeding any limit.	Tol: 1.15 %/s PFH _D : 1.8E-07	Joint (each)

Joint Torque Limit

Exceeding the internal joint torque limit (each joint) results in a Cat 0³. This is not accessible to the user; it is a factory setting. It is NOT shown as an e-Series safety function because there are no user settings and no user configurations.

SF5 Called various names: Pose Limit, Tool Limit, Orientation Limit, Safety Planes, Safety Boundaries

Description	What happens?	Tolerance and PFH _D	Affects
Monitors the TCP Pose (position and orientation) and will prevent exceeding a safety plane or TCP Pose Limit. Multiple pose limits are possible (tool flange, elbow, and up to 2 configurable tool offset points with a radius) Orientation restricted by the deviation from the feature Z direction of the tool flange OR the TCP. This safety function consists of two parts. One is the safety planes for limiting the possible TCP positions. The second is the TCP orientation limit, which is entered as an allowed direction and a tolerance. This provides TCP and wrist inclusion/ exclusion zones due to the safety planes.	Will not allow motion to exceed any limit settings. Speed or torques could be reduced so motion will not exceed any limit. A robot stop will be initiated to prevent exceeding any limit. Will not allow motion to exceed any limit settings.	Tol: 3° 40 mm PFH _D : 1.8E-07	TCP Tool flange Elbow

SF6 Speed Limit TCP & Elbow

Description	What happens?	Tolerance and PFH _D	Affects
Monitors the TCP and elbow speed to prevent exceeding a speed limit.	Will not allow motion to exceed any limit settings. Speed or torques could be reduced so motion will not exceed any limit. A robot stop will be initiated to prevent exceeding any limit. Will not allow motion to exceed any limit settings.	Tol:50 mm/s PFH _D : 1.8E-07	TCP

SF7 Force Limit (TCP)

Description	What happens?	Tolerance and PFH _D	Affects
<p>The Force Limit is the force exerted by the robot at the TCP (tool center point) and “elbow”. The safety function continuously calculates the torques allowed for each joint to stay within the defined force limit for both the TCP & the elbow. The joints control their torque output to stay within the allowed torque range. This means that the forces at the TCP or elbow will stay within the defined force limit. When a monitored stop is initiated by the Force Limit SF, the robot will stop, then “back-off” to a position where the force limit was not exceeded. Then it will stop again.</p>	<p>Will not allow motion to exceed any limit settings. Speed or torques could be reduced so motion will not exceed any limit. A robot stop will be initiated to prevent exceeding any limit. Will not allow motion to exceed any limit settings.</p>	<p>Tol: 25N PFH_D: 1.8E-07</p>	<p>TCP</p>

SF8 Momentum Limit

Description	What happens?	Tolerance and PFH _D	Affects
<p>The momentum limit is very useful for limiting transient impacts. The Momentum Limit affects the entire robot.</p>	<p>Will not allow motion to exceed any limit settings. Speed or torques could be reduced so motion will not exceed any limit. A robot stop will be initiated to prevent exceeding any limit. Will not allow motion to exceed any limit settings.</p>	<p>Tol: 3kg m/s PFH_D: 1.8E-07</p>	<p>Robot</p>

SF9 Power Limit

Description	What happens?	Tolerance and PFH _D	Affects
<p>This function monitors the mechanical work (sum of joint torques times joint angular speeds) performed by the robot, which also affects the current to the robot arm as well as the robot speed. This safety function dynamically limits the current/ torque but maintains the speed.</p>	<p>Dynamic limiting of the current/torque</p>	<p>Tol: 10W PFH_D: 1.8E-07</p>	<p>Robot</p>

SF10 UR Robot Estop Output

Description	What Happens	PFH _D	Affects
<p>When configured for a Robot <Estop> output and there is a robot stop, the dual outputs are LOW. If there is no Robot <Estop> Stop initiated, dual outputs are high. Pulses are not used but they are tolerated.</p> <p>These dual outputs change state for any external Estop that is connected to configurable safety inputs where this input is configured as an Emergency Stop input. For the integrated functional safety rating with an external safety-related control system, add the PFHD of this safety-related output to the PFHD of the external safety-related control system.</p> <p>For the Estop Output, validation is performed at the external equipment, as the UR output is an input to this external Estop safety function for external equipment.</p> <p>NOTE: If the IMMI (Injection Moulding Machine Interface) is used, the UR Robot Estop output is NOT connected to the IMMI. There is no Estop output signal sent from the UR robot to the IMMI. This is a feature to prevent an unrecoverable stop condition.</p>	<p>Dual outputs go low in event of an Estop if configurable outputs are set</p>	<p>1.8E-07</p>	<p>External connection to logic and/or equipment</p>

SF11 UR Robot Moving: Digital Output

Description	What Happens	PFH _D	Affects
<p>Whenever the robot is moving (motion underway), the dual digital outputs are LOW. Outputs are HIGH when no movement. The functional safety rating is for what is within the UR robot. The integrated functional safety performance requires adding this PFHd to the PFHd of the external logic (if any) and its components.</p>	<p>If configurable outputs are set:</p> <ul style="list-style-type: none"> When the robot is moving (motion underway), the dual digital outputs are LOW. Outputs are HIGH when no movement. 	<p>1.8E-07</p>	<p>External connection to logic and/or equipment</p>



**SF12 UR Robot
Not stopping:
Digital Output**

Description	PFH _D	Affects
When the robot is STOPPING (in process of stopping or in a stand-still condition) the dual digital outputs are HIGH. When outputs are LOW, robot is NOT in the process or stopping and NOT in a stand-still condition. The functional safety rating is for what is within the UR robot. The integrated functional safety performance requires adding this PFHd to the PFHd of the external logic (if any) and its components.	1.8E-07	External connection to logic and/or equipment

**SF13 UR Robot
Reduced Mode:
Digital Output**

Description	PFH _D	Affects
When the robot is in reduced mode (or reduced mode is initiated), the dual digital outputs are LOW. See below. The functional safety rating is for what is within the UR robot. The integrated functional safety performance requires adding this PFHd to the PFHd of the external logic (if any) and its components.	1.8E-07	External connection to logic and/or equipment

**SF14 UR Robot
Not Reduced
Mode: Digital
Output**

Description	PFH _D	Affects
Whenever the robot is NOT in reduced mode (or the reduced mode is not initiated), the dual digital outputs are LOW. The functional safety rating is for what is within the UR robot. The integrated functional safety performance requires adding this PFHd to the PFHd of the external logic (if any) and its components.	1.8E-07	External connection to logic and/or equipment

SF15 Stopping Time Limit

Description	What happens?	Tolerances and PFH _D :	Affects
<p>Real time monitoring of conditions such that the stopping time limit will not be exceeded. Robot speed is limited to ensure that the stop time limit is not exceeded.</p> <p>The stopping capability of the robot in the given motion(s) is continuously monitored to prevent motions that would exceed the stopping limit. If the time needed to stop the robot is at risk of exceeding the time limit, the speed of motion is reduced to ensure the limit is not exceeded. A robot stop will be initiated to prevent exceeding the limit. The safety function performs the same calculation of the stopping time for the given motion(s) and initiates a cat 0 stop if the stopping time limit will be or is exceeded.</p>	<p>Will not allow the actual stopping time to exceed the limit setting. Causes decrease in speed or a robot stop so as NOT to exceed the limit</p>	<p>TOL: 50 ms PFH_D: 1.8E-07</p>	<p>Robot</p>

SF16 Stopping Distance Limit

Description	What happens?	Tolerances and PFH _D :	Affects
<p>Real time monitoring of conditions such that the stopping distance limit will not be exceeded. Robot speed is limited to ensure that the stop distance limit will not be exceeded.</p> <p>The stopping capability of the robot in the given motion(s) is continuously monitored to prevent motions that would exceed the stopping limit. If the time needed to stop the robot is at risk of exceeding the time limit, the speed of motion is reduced to ensure the limit is not exceeded. A robot stop will be initiated to prevent exceeding the limit. The safety function performs the same calculation of the stopping distance for the given motion(s) and initiates a cat 0 stop if stopping time limit will be or is exceeded.</p>	<p>Will not allow the actual stopping time to exceed the limit setting. Causes decrease in speed or a robot stop so as NOT to exceed the limit</p>	<p>TOL: 40 mm PFH_D: 1.8E-07</p>	<p>Robot</p>

SF17 Safe Home Position "monitored position"

Description	What happens?	Tolerances and PFH _D :	Affects
Safety function which monitors a safety rated output, such that it ensures that the output can only be activated when the robot is in the configured and monitored "safe home position". A stop cat 0 is initiated if the output is activated when the robot is not in the configured position.	The "safe home output" can only be activated when the robot is in the configured "safe home position"	TOL: 1.7 ° PFH _D : 1.8E-07	External connection to logic and/or equipment

Table 1 footnotes

¹Communications between the Teach Pendant, controller and within the robot (between joints) are SIL 2 for safety data, per IEC 61784-3.

²Estop validation: the pendant Estop pushbutton is evaluated within the pendant, then communicated¹ to the safety controller by SIL2 communications. To validate the pendant Estop functionality, press the Pendant Estop pushbutton and verify that an Estop results. This validates that the Estop is connected within the pendant, the estop functions as intended, and the pendant is connected to the controller.

³Stop Categories according to IEC 60204-1 (NFPA79). For the Estop, only stop category 0 and 1 are allowed according to IEC 60204-1.

- Stop Category 0 and 1 result in the removal of drive power, with stop cat 0 being IMMEDIATE and stop cat 1 being a controlled stop (e.g. decelerate to a stop then removal of drive power). With UR robots, a stop category 1 is a controlled stop where power is removed when a monitored standstill is detected.
- Stop Category 2 is a stop where drive power is NOT removed. Stop category 2 is defined in IEC 60204-1. Descriptions of STO, SS1 and SS2 are in IEC 61800-5-2. With UR robots, a stop category 2 maintains the trajectory, then retains power to the drives after stopping.

⁴It is recommended to use the UR Stop Time and Stop Distance Safety Functions. These limits should be used for your application stop time/ safety distance values.

⁵Robot stop was previously known as "Protective stop" for Universal Robots robots.

16.1. Table 1a

Reduced Mode SF parameter settings change

Description	PFH _D	Affects
<p>Reduced Mode can be initiated by a safety plane/ boundary (starts at 2cm of the plane and reduced mode settings are achieved within 2cm of the plane) or by use of an input to initiate (will achieve reduced settings within 500ms). When the external connections are Low, Reduced Mode is initiated. Reduced Mode means that ALL reduced mode limits are ACTIVE.</p> <p>Reduced mode is not a safety function, rather it is a state change affecting the settings of the following safety function limits: joint position, joint speed, TCP pose limit, TCP speed, TCP force, momentum, power, stopping time, and stopping distance. Reduced mode is a means of parametrization of safety functions in accordance with ISO 13849-1. All parameter values need to be verified and validated as to whether they are appropriate for the robot application.</p>	Less than 1.8E-07	Robot

Safeguard Reset

Description	PFH _D	Affects
When configured for Safeguard Reset and the external connections transition from low to high, the safeguard stop RESETS. Safety input to initiate a reset of safeguard stop safety function.	Less than 1.8E-07 Input to SF2	Robot

3-Position Enabling Device INPUT

Description	PFH _D	Affects
<p>When the external Enabling Device connections are Low, a Safeguard Stop (SF2) is initiated. Recommendation: Use with a mode switch as a safety input. If a mode switch is not used and connected to the safety inputs, then the robot mode will be determined by the User Interface. If the User Interface is in:</p> <ul style="list-style-type: none"> “running mode”, the enabling device will not be active. “programming mode”, the enabling device will be active. It is possible to use password protection for changing the mode by the User Interface. 	Less than 1.8E-07 Input to SF2	Robot

Mode switch INPUT

Description	PFH _D	Affects
When the external connections are Low, Operation Mode (running/ automatic operation in automatic mode) is in effect. When High, mode is programming/ teach. Recommendation: Use with an enabling device, for example a UR e-Series Teach Pendant with an integrated 3-position enabling device. When in teach/program, initially both TCP speed and elbow speed will be limited to 250mm/s. The speed can manually be increased by using the pendant user interface “speed-slider”, but upon activation of the enabling device, the speed limitation will reset to 250mm/s.	Less than 1.8E-07 Input to SF2	Robot

Freedrive INPUT

Description	PFH _D	Affects
Recommendation: Use with 3PE TP and/or 3 Position Enabling Device INPUT. When Freedrive INPUT is High, the robot will only enter Freedrive if the following conditions are satisfied: <ul style="list-style-type: none"> • 3PE TP button is not pressed • 3 Position Enabling Device INPUT either not configured or not pressed (INPUT Low) 	Less than 1.8E-07 Input to SF2	Robot

16.2. Table 2

Description

UR e-Series robots comply with ISO 10218-1:2011 and the applicable portions of ISO/TS 15066. It is important to note that most of ISO/TS 15066 is directed towards the integrator and not the robot manufacturer. ISO 10218-1:2011, clause 5.10 collaborative operation details 4 collaborative operation techniques as explained below. It is very important to understand that collaborative operation is of the APPLICATION when in AUTOMATIC mode.

Collaborative Operation 2011 edition, clause 5.10.2

Technique	Explanation	UR e-Series
Safety-rated monitored stop	Stop condition where position is held at a standstill and is monitored as a safety function. Category 2 stop is permitted to auto reset. In the case of resetting and restarting operation after a safety -rated monitored stop, see ISO 10218-2 and ISO/TS 15066 as resumption shall not cause hazardous conditions.	UR robots’ safeguard stop is a safety-rated monitored stop, See SF2 on page 1. It is likely, in the future, that “safety-rated monitored stop” will not be called a form of collaborative operation.

**Collaborative
Operation 2011
edition, clause
5.10.3**

Technique	Explanation	UR e-Series
Hand-guiding	<p>This is essentially individual and direct personal control while the robot is in automatic mode. Hand guiding equipment shall be located close to the end-effector and shall have:</p> <ul style="list-style-type: none"> • an Emergency Stop pushbutton • a 3-position enabling device • a safety-rated monitored stop function • a settable safety-rated monitored speed function 	<p>UR robots do not provide hand-guiding for collaborative operation. Hand-guided teach (free drive) is provided with UR robots but this is for programming in manual mode and not for collaborative operation in automatic mode.</p>



Collaborative Operation 2011 edition, clause 5.10.4

Technique	Explanation	UR e-Series
<p>Speed and separation monitoring (SSM) safety functions</p>	<p>SSM is the robot maintaining a separation distance from any operator (human). This is done by monitoring of the distance between the robot system and intrusions to ensure that the MINIMUM PROTECTIVE DISTANCE is assured. Usually, this is accomplished using Sensitive Protective Equipment (SPE), where typically a safety laser scanner detects intrusion(s) towards the robot system. This SPE causes:</p> <ol style="list-style-type: none"> 1. dynamic changing of the parameters for the limiting safety functions; or 2. a safety-rated monitored stop condition. <p>Upon detection of the intrusion exiting the protective device's detection zone, the robot is permitted to:</p> <ol style="list-style-type: none"> 1. resume the "higher" normal safety function limits in the case of 1) above 2. resume operation in the case of 2) above <p>In the case of 2) 2), restarting operation after a safety -rated monitored stop, see ISO 10218-2 and ISO/TS 15066 for requirements.</p>	<p>To facilitate SSM, UR robots have the capability of switching between two sets of parameters for safety functions with configurable limits (normal and reduced). See Reduced Mode on page 4. Normal operation can be when no intrusion is detected. It can also be caused by safety planes/ safety boundaries. Multiple safety zones can be readily used with UR robots. For example, one safety zone can be used for "reduced settings" and another zone boundary is used as a safeguard stop input to the UR robot. Reduced limits can also include a reduced setting for the stop time and stop distance limits - to reduce the work area and floorspace.</p>

**Collaborative
Operation 2011
edition, clause
5.10.5**

Technique	Explanation	UR e-Series
Power and force limiting (PFL) by inherent design or control	How to accomplish PFL is left to the robot manufacturer. The robot design and/or safety functions will limit the energy transfer from the robot to a person. If any parameter limit is exceeded, a robot stop happens. PFL applications require considering the ROBOT APPLICATION (including the end-effector and workpiece(s), so that any contact will not cause injury. The study performed evaluated pressures to the ONSET of pain, not injury. See Annex A. See ISO/TR 20218-1 End-effectors.	UR robots are power and force limiting robots specifically designed to enable collaborative applications where the robot could contact a person and cause no injury. UR robots have safety functions that can be used to limit motion, speed, momentum, force, power and more of the robot. These safety functions are used in the robot application to thereby lessen pressures and forces caused by the end-effector and workpiece(s).

Part II PolyScope X Software Manual



UNIVERSAL ROBOTS

User Manual

PolyScope X



The information contained herein is the property of Universal Robots A/S and shall not be reproduced in whole or in part without prior written approval of Universal Robots A/S. The information herein is subject to change without notice and should not be construed as a commitment by Universal Robots A/S. This document is periodically reviewed and revised.

Universal Robots A/S assumes no responsibility for any errors or omissions in this document.

Copyright © 2009-2024 by Universal Robots A/S.

The Universal Robots logo is a registered trademark of Universal Robots A/S.



Contents

1. Preface	8
Part I Hardware Installation Manual	11
2. Safety	12
2.1. Validity and Responsibility	13
2.2. Limitation of Liability	13
2.3. Safety Message Types	14
2.4. General Warnings and Cautions	15
2.5. Intended Use	17
2.6. Risk Assessment	20
2.7. Pre-Use Assessment	23
2.8. Emergency Stop	24
2.9. Movement Without Drive Power	25
2.10. Safety-related Functions and Interfaces	26
2.10.1. Stop Categories	26
2.10.2. Configurable Safety Functions	28
2.10.3. Safety Functions	32
2.10.4. Safety Parameter Set	33
2.10.5. Modes	35
3. Mechanical Interface	36
3.1. Workspace and Operating Space	36
3.2. Mounting Description	37
3.3. Securing the Robot Arm	40
3.4. Securing Tool	44
3.5. Control Box Clearance	44
3.6. Maximum Payload	46
4. Electrical Interface	47
4.1. Electrical Warnings and Cautions	47
4.2. Controller I/O	49
4.3. Safety I/O	51
4.4. Three Position Enabling Device	56
4.5. General Purpose Digital I/O	57
4.6. General Purpose Analog I/O	58
4.7. Remote ON/OFF Control	59
4.8. Control Box Connection Ports	61
4.9. Ethernet	61
4.10. Mains Connections	62



4.11. Robot Connections: Robot Cable	64
4.12. Robot Connections: Base Flange Cable	66
4.13. Tool I/O	67
4.14. Tool Power Supply	69
4.15. Tool Digital Outputs	70
4.16. Tool Digital Inputs	71
4.17. Tool Analogue Inputs	71
4.18. Tool Communication I/O	72
5. Transportation	73
5.1. Transport Without Packaging	74
6. Maintenance and Repair	75
7. Robot Arm Cleaning and Inspection	76
8. Disposal and Environment	80
9. Certifications	82
10. Stopping Time and Stopping Distance	84
11. Declarations and Certificates (original EN)	89
12. Warranty Information	91
13. Certificates	92
14. Applied Standards	97
15. Technical Specifications UR5e	106
16. Safety Functions Table 1	107
16.1. Table 1a	115
16.2. Table 2	116
Part II PolyScope X Software Manual	122
17. Preface	130
17.1. What Do the Boxes Contain	131
17.2. Important Safety Notice	131
17.3. How to Read this Manual	131
17.4. Purpose of this Manual	132
18. Robot Arm Basics	133
18.1. Teach Pendant	133
18.1.1. Using the screen	133
19. Install the robot	134
19.1. Assembling the robot arm and Control Box	134
20. PolyScope X Overview	135
20.0.1. Screen Layout	135
20.0.2. Screen Combinations	135

20.1. Touch Screen	136
20.2. Icons	137
21. Initialize	139
21.1. Starting the Robot Arm	139
21.2. Safely Setting the Active Payload	139
22. Safety	140
22.1. Safety Checksum	140
22.2. Safety Configuration	140
22.3. Setting a Safety Password	140
22.4. Safety Menu Settings	141
22.4.1. Robot Limits	141
22.4.2. Safety I/O Signals	142
22.4.3. Safety Planes	144
To restrict the elbow joint	145
23. Operational Mode	146
24. Application Tab	148
24.1. Communication	148
25. Glossary	150
25.1. Index	151

17. Preface



Copyright © 2009-2024 by Universal Robots A/S. All rights reserved.

Congratulations on the purchase of your new Universal Robots e-Series robot.

The robot can be programmed to move a tool, and communicate with other machines using electrical signals. It is an arm composed of extruded aluminum tubes and joints.

Using our PolyScope X programming interface, it is easy to program the robot to move the tool along a desired trajectory.

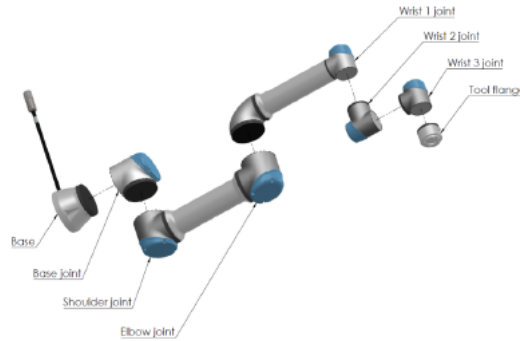

2.1: The joints, the base and the tool flange of the Robot Arm.

With six joints and a wide scope of flexibility, Universal Robots e-Series collaborative robot arms are designed to mimic the range of motion of a human arm. Using our patented programming interface, PolyScope, it is easy to program the robot to move tools and communicate with other machines using electrical signals. Figure 2.1 [The joints, the base and the tool flange of the Robot Arm.](#) above illustrates the main components of the robot arm and can be used as a reference throughout the manual.

17.1. What Do the Boxes Contain

When you order a robot, you receive two boxes. One contains the robot arm, the other contains:

- Control Box with Teach Pendant
- Mounting bracket for the Control Box
- Mounting bracket for the Teach Pendant
- Key for opening the Control Box
- Cable for connecting the robot arm and the Control Box
- Mains cable or Power cable compatible to your region
- This manual

17.2. Important Safety Notice

The robot is **partly completed machinery** (see [22 Safety on page 140](#)) and as such a risk assessment is required for each installation of the robot. You must follow all of the safety instructions in chapter [22 Safety on page 140](#).

17.3. How to Read this Manual

This manual contains instructions for installing and programming the robot. The manual is separated into two parts:

Hardware Installation Manual

The mechanical and electrical installation of the robot.

PolyScope X Manual

Programming of the robot.

This manual is intended for the robot integrator who must have a basic level of mechanical and electrical training, as well as be familiar with elementary programming concepts.



17.4. Purpose of this Manual

The purpose of this document is to allow for the safe setup of a Universal Robots robot arm with the PolyScope X software. The instructions in this document shall be considered as general guidelines.

It is assumed that the integrator has a high level of technical knowledge.

Universal Robots disclaims any liability, even though all guidelines contained within this document are followed.

Always perform a thorough risk assessment for the specific application.

Consult the safety section in the Universal Robots User Manual for general precautions.

18. Robot Arm Basics

The Universal Robots robot arm is composed of tubes and joints. The coordinated motion of these tubes and joints, via PolyScope X software, moves the robot arm.

- **Base**: where the robot arm is mounted.
- **Shoulder** and **Elbow**: where the larger movements originate.
- **Wrist 1** and **Wrist 2**: where the finer movements originate.
- **Wrist 3**: where the tool attaches to the tool flange.

You can attach a tool to the flange at the end of Wrist 3. Moving the robot arm positions the tool.



CAUTION

You cannot position the tool directly above, or directly below the Base.

18.1. Teach Pendant

The Teach Pendant, the touch screen that controls the robot, is optimised for use in industrial environments. Unlike consumer electronics, the Teach Pendant touch screen sensitivity is, by design, more resistant to environmental factors such as:

- Water droplets and/or machine coolant droplets
- Radio wave emissions
- other conducted noise from the operating environment

The touch sensitivity is designed to avoid false selections on the interface, and to prevent unexpected motion of the robot.

18.1.1. Using the screen

For best results, use the tip of your finger to make a selection on the screen.

In this manual, this is referred to as a "tap".

A commercially available stylus may be used to make selections on the screen if desired.

19. Install the robot

To start using PolyScope X, make sure your robot arm and Control Box are assembled and the power cable is plugged in.

19.1. Assembling the robot arm and Control Box

If the robot is not assembled, you may need to assemble and mount the robot arm and Control Box.



WARNING

Tipping hazard. If the robot is not securely placed on a sturdy surface, the robot can fall over and cause injury.

To assemble and power-on the robot arm

1. Unpack the robot arm and the Control Box.
2. Mount the robot arm on a sturdy, vibration-free surface, using screws and a hex key (Allen wrench).
Mounting the robot may require two people.
3. Place the Control Box on its Foot.
4. Connect the robot cable to the robot arm and the Control Box.
5. Plug in the main/power cable of the control box.
6. Press the power button on the Teach Pendant to turn on the robot.

20. PolyScope X Overview

PolyScope X is the Graphical User Interface (GUI) installed on the Teach Pendant that operates the robot arm via a touch screen. The PolyScope X interface allows you to create, load and execute programs.

20.0.1. Screen Layout

The interface is divided as shown in the following illustration:

- **Header** - with button to load or create programs and access program modules.
- **Left Header** - with icons/tabs to select a main screen.
- **Right Header** - with icons/tabs to select a multitask screen.
- **Footer** - with buttons to control robot power and your loaded program.

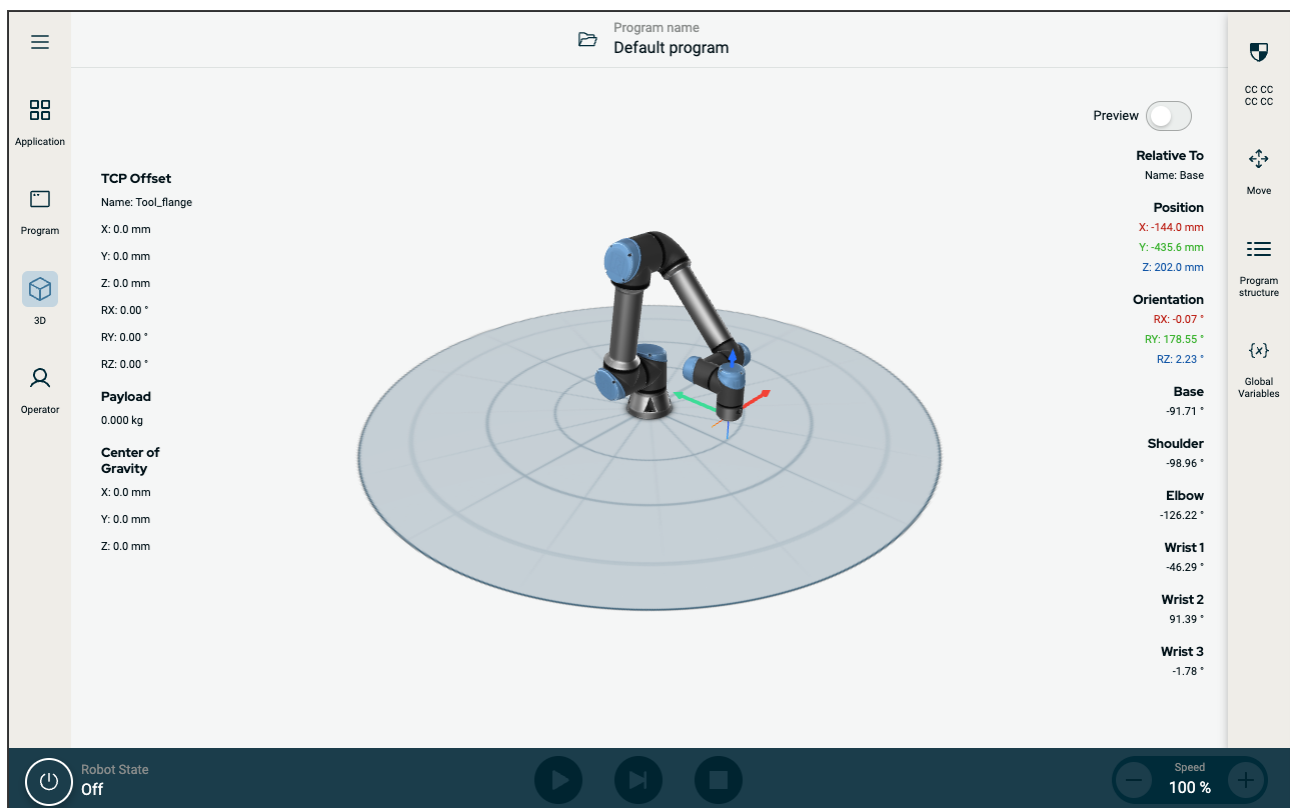

Figure 2.2: Main screen

20.0.2. Screen Combinations

The main screen and the multitask screen make up the operating screen combination for the robot.

The multitask screen is independent of the main screen, so you can do separate tasks. For example, you can configure a program in the main screen, while moving the robot arm in the multitask screen. You also can hide the multitask screen if it is not needed.

- **Main screen** - with fields and options to manage and monitor robot actions.
- **Multitask screen** - with fields and options often relating to the main screen.

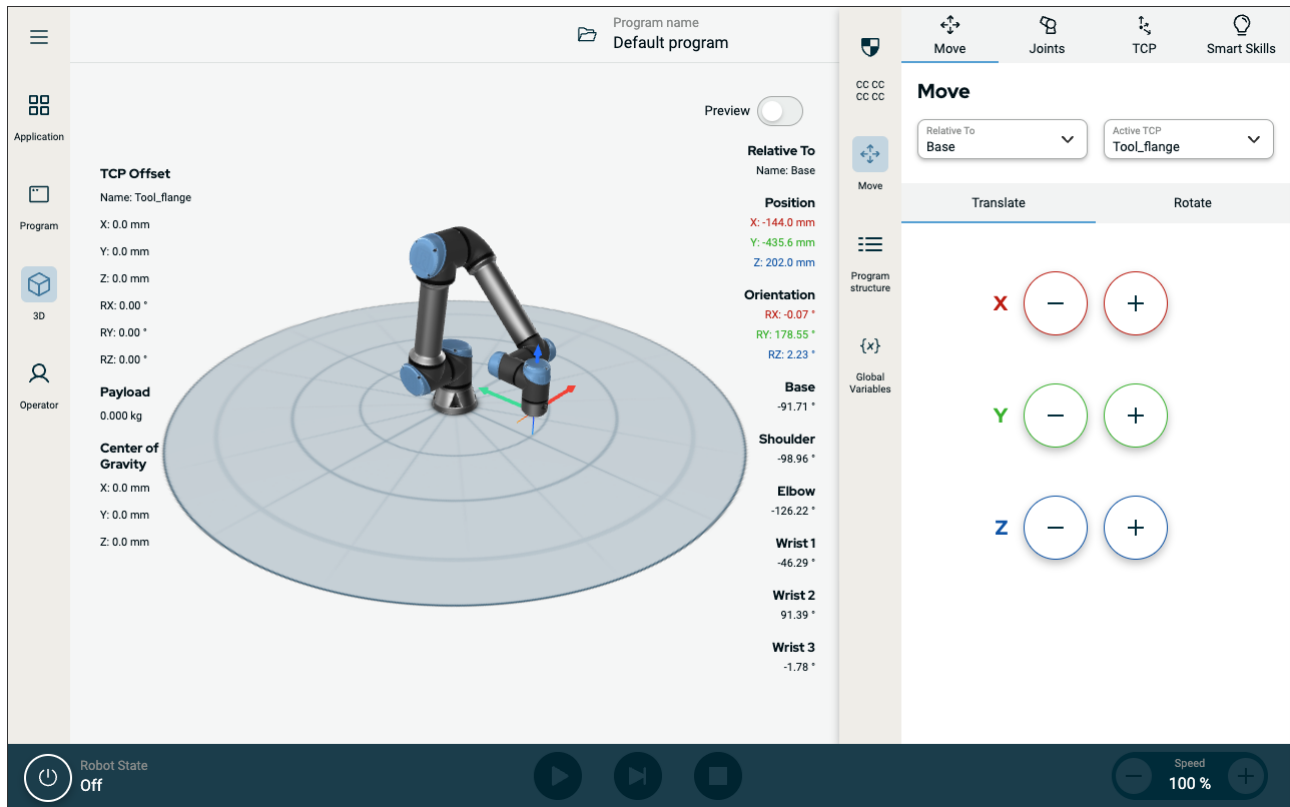

Figure 2.3: Main screen and multitask screen

To show/hide the multitask screen

1. In the right header, tap any icon to show the multitask screen.
The right header expands to the middle of the screen to accommodate the multitask screen.
2. Tap the currently selected icon in the right header to hide the multitask screen.

20.1. Touch Screen

The Teach Pendant touch screen is optimised for use in industrial environments. Unlike consumer electronics, Teach Pendant touch screen sensitivity is, by design, more resistant to environmental factors such as:

- Water droplets and/or machine coolant droplets
- Radio wave emissions
- Other conducted noise from the operating environment

The touch sensitivity is designed to avoid false selections on Polyscope X, and to prevent unexpected motion of the robot.

Using the Touch Screen

For best results, use the tip of your finger to make a selection on the screen. In this manual, this is referred to as a "tap". A commercially available stylus may be used to make selections on the screen if desired. The following section lists and defines the icons/tabs and buttons in the Polyscope X interface.

The following section lists and defines the icons/tabs and buttons in the Polyscope X interface.

20.2. Icons

Left Header Icons

Icon	Title	Description
	Operator	A simple means of operating the robot using pre-written programs
	Application	To configure the robot arm settings and external equipment, eg mounting and TCPs
	Program	Modifies the current robot program
	3D	Controls and/or regulates robot movement
	More	Access to About information and Settings
	About	Displays information about the robot
	Settings	To configure settings about the software, eg language and units
	Shutdown	To shutdown the robot
CCCC CCCC	Safety Checksum	Displays the active safety checksum and detailed parameters

Footer Buttons

Icon	Title	Description
------	-------	-------------

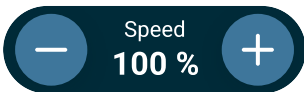

Initialize

Manages the robot state. When RED, press it to make the robot operational.

- Black, Power off. The robot arm is in a stopped state.
- Orange, Idle. The robot arm is on, but not ready for normal operation.
- Orange, Locked. The robot arm is locked.
- Green, Normal. The robot arm is on and ready for normal operation.
- Red, Error. The robot is in a fault state, such as e-stop.
- Blue, Transition. The robot is changing state, such as brake releasing.

Play

Starts the current loaded program.

Step

Allows a program to be run single-stepped

Stop

Halts the current loaded program

Speed slider

Manages the robot state. When RED, press it to make the robot operational

21. Initialize

On the footer, to the left, the Initialize button indicates the status of the robot using colours:

- Black, Power off. The robot arm is in a stopped state.
- Orange, Idle. The robot arm is on, but not ready for normal operation.
- Green, Normal. The robot arm is on and ready for normal operation.
- Red, Error. The robot is in a fault state, such as e-stop.
- Blue, Transition. The robot is changing state, such as brake releasing.

21.1. Starting the Robot Arm



WARNING

Always verify the actual payload and installation are correct before starting up the robot arm. If these settings are incorrect, the robot arm and Control Box will not function correctly and may become dangerous to people or equipment.



CAUTION

Ensure the robot arm is not touching an object (e.g., a table) because a collision between the robot arm and an obstacle might damage a joint gearbox.

To start the robot:

- Tap the Robot State Off, followed by the START button with the green icon to start the initialization process. Then, the icon turns orange to indicate the power is on and in Idle.
- Tap the UNLOCK button with the orange icon to release the brakes.
- Tap the POWER OFF button with the red icon to power off the robot arm.

21.2. Safely Setting the Active Payload

Before using Polyscope X, verify that the Robot Arm and Control Box are correctly installed.

1. On the Teach Pendant, press the emergency stop button.
2. On the Teach Pendant, press the power button and allow the system to start, loading Polyscope X.
3. Tap the Robot State Off button on the bottom left
4. Unlock the emergency stop button to change robot state from Emergency Stopped to Power off.
5. Step outside the reach (workspace) of the robot.
6. On the Initialize popup, tap the START button and allow robot state to change to Locked.
7. In the Payload field, in Active Payload, verify the payload mass. You can also verify the mounting position is correct, in the Robot graphic.
8. Tap the UNLOCK button, for the robot to release its brake system. The robot vibrates and makes clicking sounds indicating it is ready to be programmed

22. Safety



WARNING

Before you configure your robot safety settings, your integrator must conduct a risk assessment to guarantee the safety of personnel and equipment around the robot. A risk assessment is an evaluation of all work procedures throughout the robot lifetime, conducted in order to apply correct safety configuration settings. (See Hardware Installation Manual)

22.1. Safety Checksum

The Safety Checksum icon displays your applied robot safety configuration. The checksum changes if and only if the safety configuration is changed.

22.2. Safety Configuration



NOTICE

Safety Settings are password protected.

1. In the PolyScope X left header, tap the Application icon.
2. On the Workcell screen tap the Safety icon.
3. Observe that the Robot Limits screen displays, but settings are inaccessible.
4. Enter the safety password and tap UNLOCK to make settings accessible. Note: Once Safety settings are unlocked, all settings are now active.
5. Tap LOCK or navigate away from the Safety menu to lock all Safety item settings again.

22.3. Setting a Safety Password

1. In your PolyScope X header left corner, tap the Hamburger menu and then tap Settings.
2. On the left of the screen, in the blue menu, tap Safety Password.
3. For Old Password, type the current Safety password.
4. For New Password, type a password.
5. For Repeat Password, type the same password and tap Change Password.
6. In the top right of the menu, press CLOSE to return to previous screen.

22.4. Safety Menu Settings

22.4.1. Robot Limits

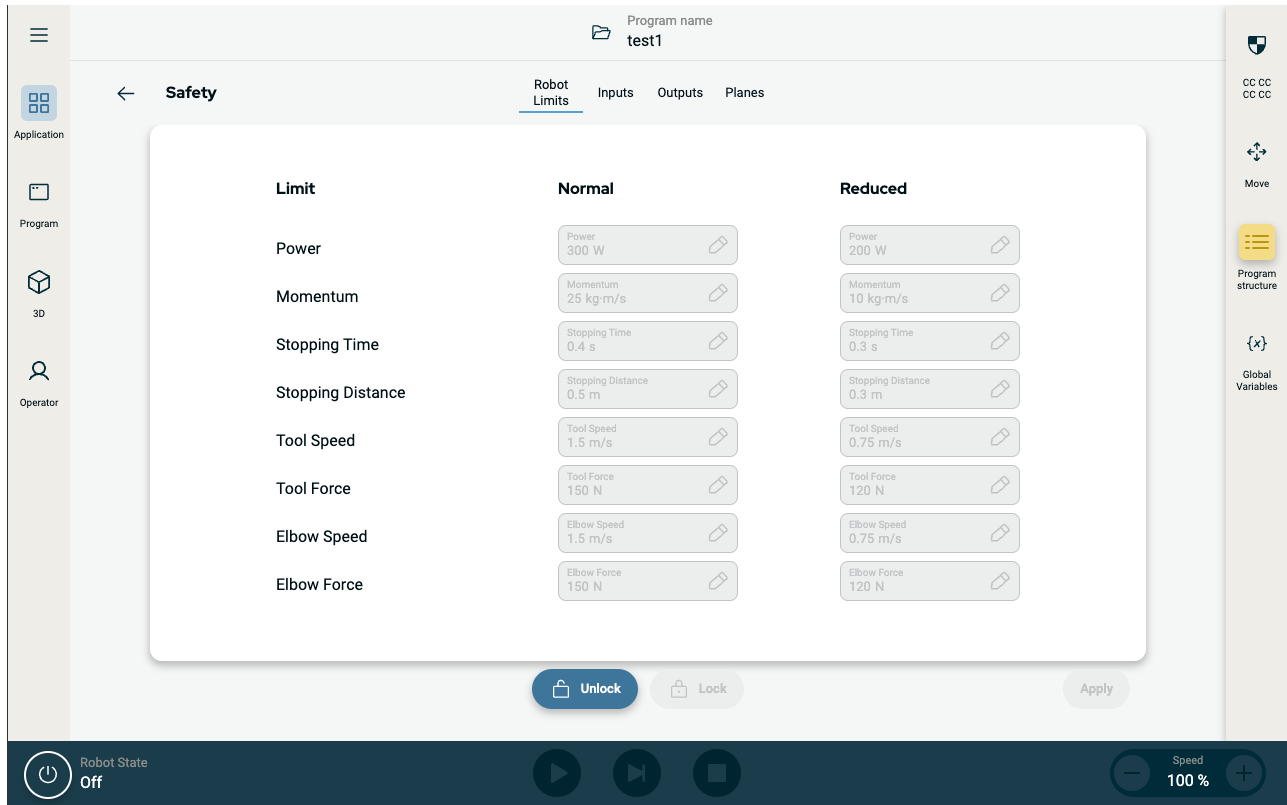

Limit	Description
Power	limits maximum mechanical work produced by the robot in the environment. This limit considers the payload a part of the robot and not of the environment.
Momentum	limits maximum robot momentum.
Stopping Time	limits maximum time it takes the robot to stop e.g. when an emergency stop is activated
Stopping Distance	limits maximum distance the robot tool or elbow can travel while stopping.
Tool Speed	limits maximum robot tool speed.
Tool Force	limits the maximum force exerted by the robot tool in clamping situations
Elbow Speed	limits maximum robot elbow speed
Elbow Force	limits maximum force that the elbow exerts on the environment



NOTICE

Restricting stopping time and distance affect overall robot speed. For example, if stopping time is set to 300 ms, the maximum robot speed is limited allowing the robot to stop within 300 ms.



NOTICE

The tool speed and force are limited at the tool flange and the center of the two user-defined tool positions

Under normal conditions, i.e. when no Robot stop is in effect, the safety system operates in a Safety Mode associated with a set of safety limits ¹:

Safety mode	Effect
Normal mode	is the safety mode that is active by default.
Reduced mode	activates when the Tool Center Point (TCP) is positioned beyond a Trigger Reduced mode plane, or when triggered using a configurable input.
Recovery mode	activates when a safety limit from the active limit set is violated, the robot arm performs a Stop Category 0. If an active safety limit, such as a joint position limit or a safety boundary, is violated already when the robot arm is powered on, it starts up in Recovery mode. This makes it possible to move the robot arm back within the safety limits. In Recovery mode, the movement of the robot arm is restricted by a fixed limit that you cannot customize.

22.4.2. Safety I/O Signals

The I/O are divided between inputs and outputs and are paired up so that each function provides a Category 3 and PLd I/O.

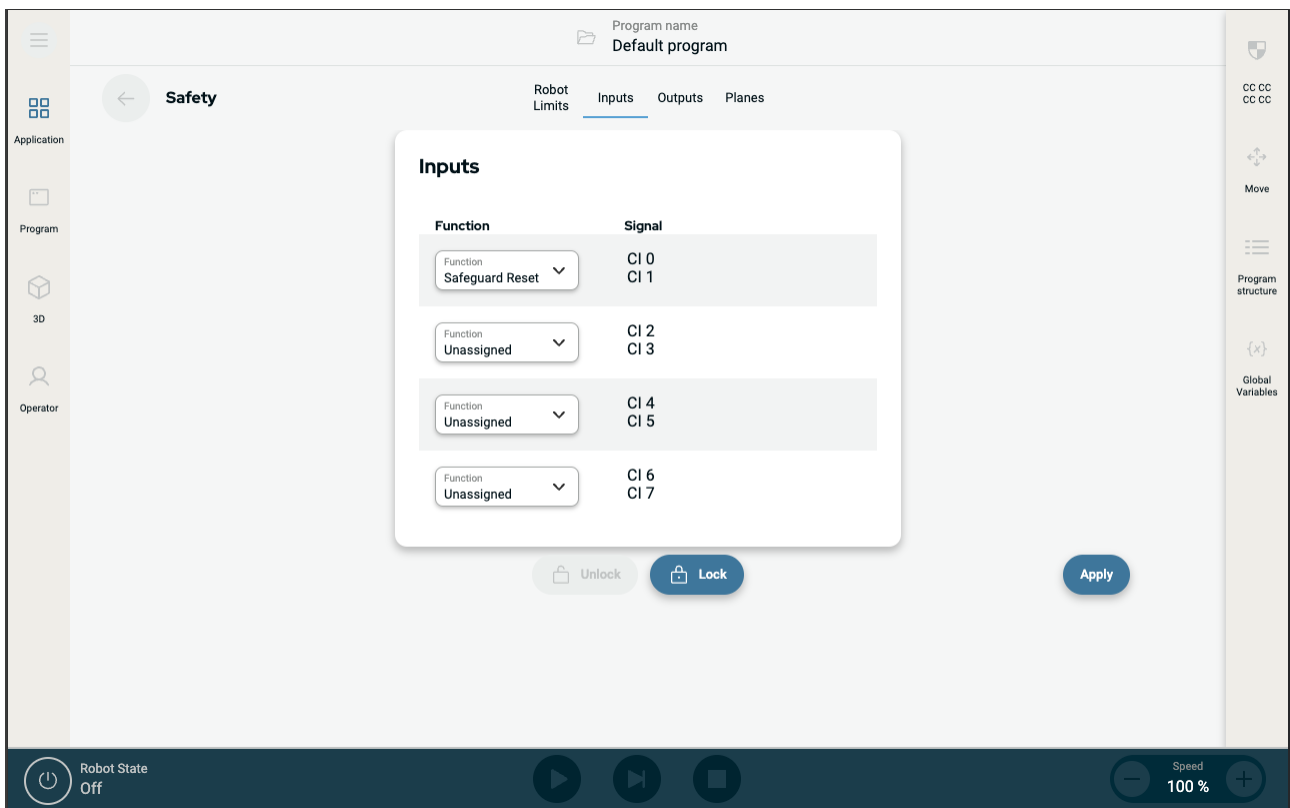
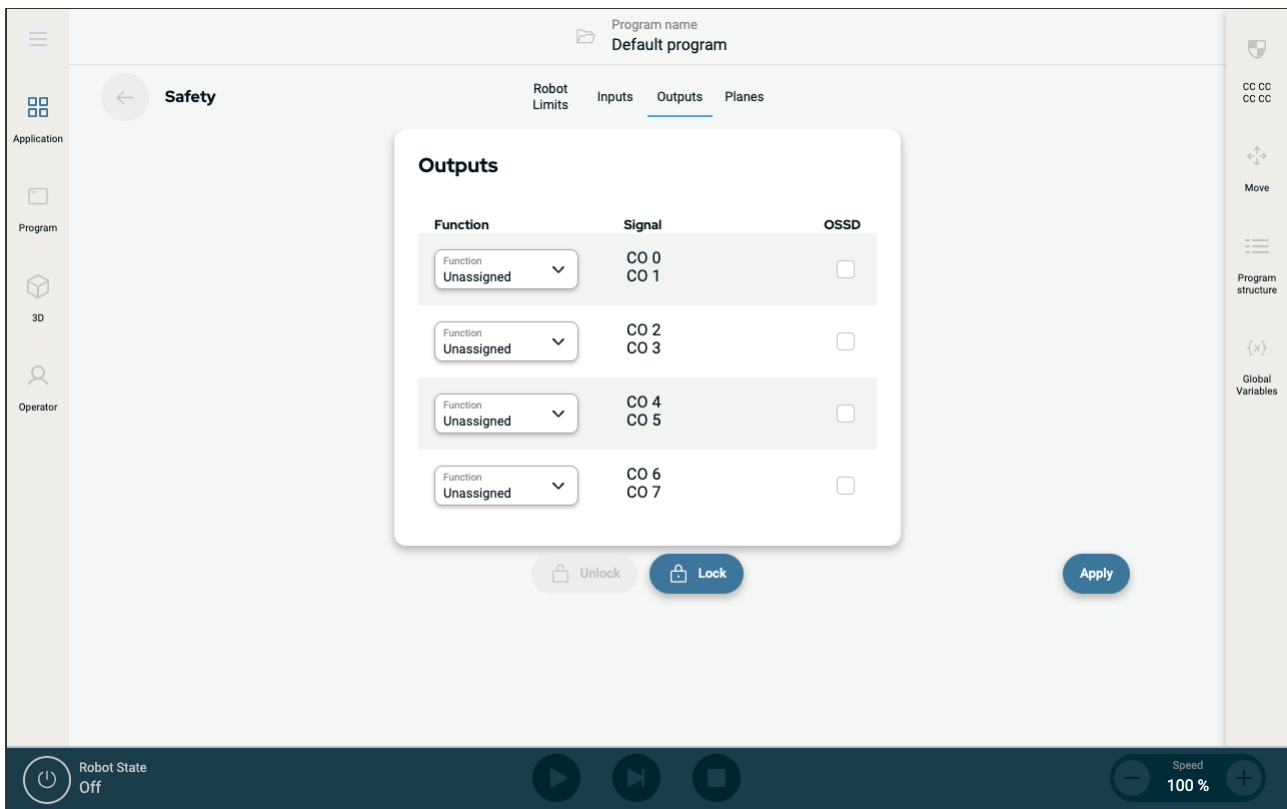

Figure 2.4: PolyScope X screen displaying the Inpu signals.

¹Robot stop was previously known as "Protective stop" for Universal Robots.



The safety functions listed in the table below can be used with the input signals

Input Signals	
System Emergency Stop	This is an emergency stop button alternative to the one on the Teach Pendant, providing the same functionality if the device complies with ISO 13850.
Reduced Mode	All safety limits can be applied in either Normal mode or Reduced mode. When configured, a low signal sent to the inputs causes the safety system to transition to Reduced mode. The robot arm decelerates to satisfy the Reduced mode limit set. The safety system guarantees that the robot is within Reduced mode limits less than 0.5s after the input is triggered. If the robot arm continues to violate any of the Reduced mode limits, it performs a Stop Category 0. Transition to Normal mode occurs in the same way. The trigger planes can also cause a transition to Reduced mode.
Safeguard Reset	When a Safeguard Stop occurs, this output ensures that the Safeguard Stop state continues until a reset is triggered.



WARNING

Disabling the default Safeguard Reset input deactivates the Safeguard Stop when the input is high. As a result any program that was paused using the Safeguard Stop will resume. This renders the robot arm unsafe.

- Do not disable default Safeguard Reset.

Output Signals	
System Emergency Stop	Signal is Low when the safety system has been triggered into an Emergency Stopped state by the Robot Emergency Stop input or the Emergency Stop Button. To avoid deadlocks, if the Emergency Stopped state is triggered by the System Emergency Stop input, low signal will not be given.
Robot Moving	Signal is Low if the robot is moving, otherwise high.
Robot Not Stopping	Signal is High when the robot is stopped or in the process of stopping due to an emergency stop or safeguard stop. Otherwise it will be logic low.
Reduced Mode	Signal is Low when the robot arm is placed in Reduced mode or if the safety input is configured with a Reduced Mode input and the signal is currently low. Otherwise the signal is high.

22.4.3. Safety Planes

Safety planes restrict robot workspace, the tool and the elbow.



WARNING

Defining safety planes only limits the defined Tool spheres and elbow, not the overall limit for the robot arm.
 Defining safety planes does not guarantee that other parts of the robot arm will obey this type of restriction.

Copyright © 2009-2024 by Universal Robots A/S. All rights reserved.

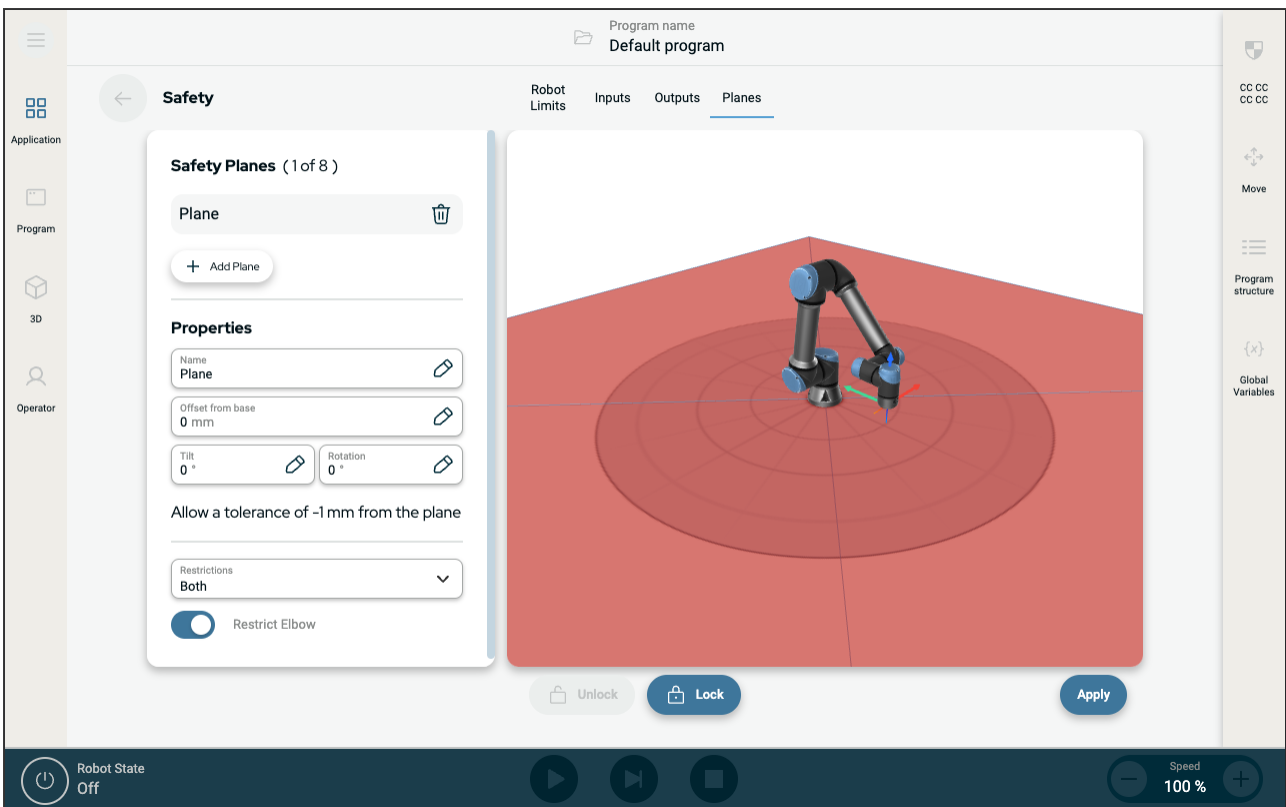

Figure 2.5: PolyScope X screen displaying safety planes.

- **Disabled:** The safety plane is never active in this state.
- **Normal:** When the safety system is in Normal mode, a normal plane is active and it acts as a strict limit on the position.
- **Reduced:** When the safety system is in Reduced mode, a reduced mode plane is active and it acts as a strict limit on the position.
- **Normal & Reduced:** When the safety system is either in Normal or Reduced mode, a normal and reduced mode plane is active and acts as a strict limit on the position.
- **Trigger Reduced Mode:** The safety plane causes the safety system to switch to Reduced mode if the robot Tool or Elbow is positioned beyond it.

Configuring a safety plane

You can configure safety planes with the properties listed below:

- **Name** This is the name used to identify the safety plane.
- **Offset from base** This is the height of the plane from the base, measured in the -Y direction.
- **Tilt** This is the tilt of the plane, measured from the power cord.
- **Rotation** This is the rotation of the plane, measured clockwise.

You can configure each plane with the restrictions listed below:

- **Normal** When the safety system is in Normal mode, a normal plane is active and it acts as a strict limit on the position.
- **Reduced** When the safety system is in Reduced mode, a reduced mode plane is active and it acts as a strict limit on the position.
- **Both** When the safety system is either in Normal or Reduced mode, a normal and reduced mode plane is active and acts as a strict limit on the position.
- **Trigger Reduced Mode** The safety plane causes the safety system to switch to Reduced mode if the robot Tool or Elbow is positioned beyond it.

Elbow Joint Restriction

You can prevent the robot elbow joint from passing through any of your defined planes.

To restrict the elbow joint

1. Disable Restrict Elbow for elbow to pass through planes.

23. Operational Mode

Description Operational Modes are enabled in the UI, and protected by a password. They can additionally be configured by defining an Operational Mode Configurable I/O.

Automatic Mode Once activated, the robot can only perform the loaded pre-defined task. The Application Tab, Program Tab, 3D Tab and Freedrive Mode are unavailable. You cannot load, modify, or save programs.

Manual Mode Once activated, you can program the robot using the 3D and Move Tab, Freedrive Mode and Speed Slider. You can modify and save programs.

Operational Mode	Manual	Automatic
Speed Slider	x	x
Move robot with +/- on Move Tab	x	
Freedrive	x	
Execute Programs	Reduced speed***	x
Edit & save program	x	

*** When tool power is enabled, a 400 ms soft start time begins allowing a capacitive load of 8000 uF to be connected to the tool power supply at start-up. Hot-plugging the capacitive load is not allowed.

Using Operational Mode Safety Input

Using Operational Mode Safety Input

1. Tap the Application Tab, then the Safety Icon, and select Safety Inputs.
2. Configure the Operational Mode Input. The option to configure appears in the drop-down menu.
 - a. The robot is in Automatic Mode when the Operational Mode Input is low.
 - b. The robot is in Manual Mode when the Operational Mode Input is high.

Switching Modes To switch between modes, in the Right Header, select the profile icon to display the Mode Section.

- Automatic indicates the operational mode of the robot is set to Automatic.
- Manual indicates the operational mode of the robot is set to Manual.

PolyScope X is automatically in Manual Mode when the Safety I/O configuration with Three-Position Enabling Device is enabled.

24. Application Tab

The Application tab allows you to configure the settings which affect the overall performance of the robot and PolyScope X.

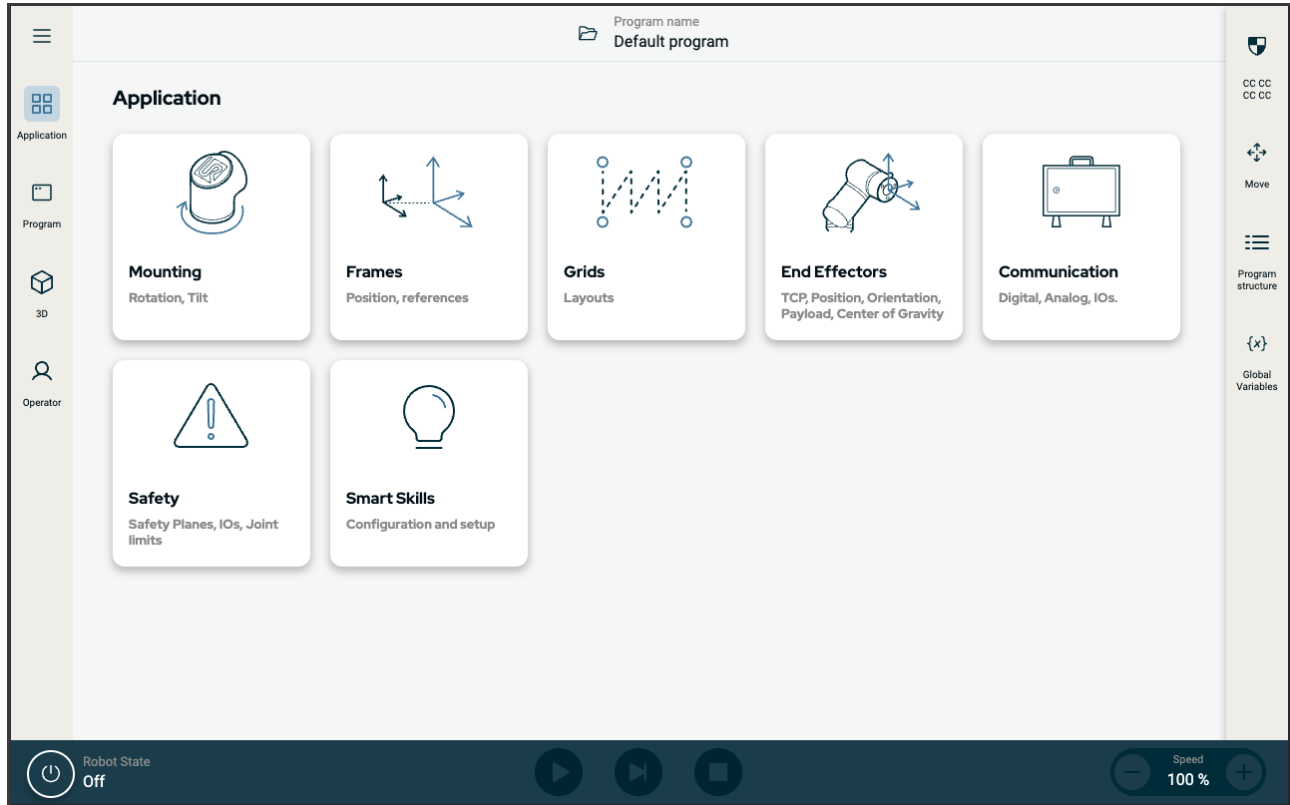

Figure 2.6: Application screen displaying application buttons.

Use the Application tab to access to the following configuration screens:

- Mounting
- Frames
- Grids
- End Effectors
- Communication
- Safety
- Smart Skills

24.1. Communication

The Communication screen allows you to monitor and set the live I/O signals from/to the robot control box. The screen displays the current state of the I/O, including during program execution. If anything is changed during program execution, the program stops. At program stop, all output signals retain their states.

The Communication screen updates at 10Hz, so very fast signals may not display properly. You can reserve configurable I/Os for special safety settings defined in [22.4.2 Safety I/O Signals on page 142](#). Those which are reserved will have the name of the safety function in place of the default or user defined name. Configurable outputs reserved for safety settings cannot be selected, they are displayed as LEDs only.

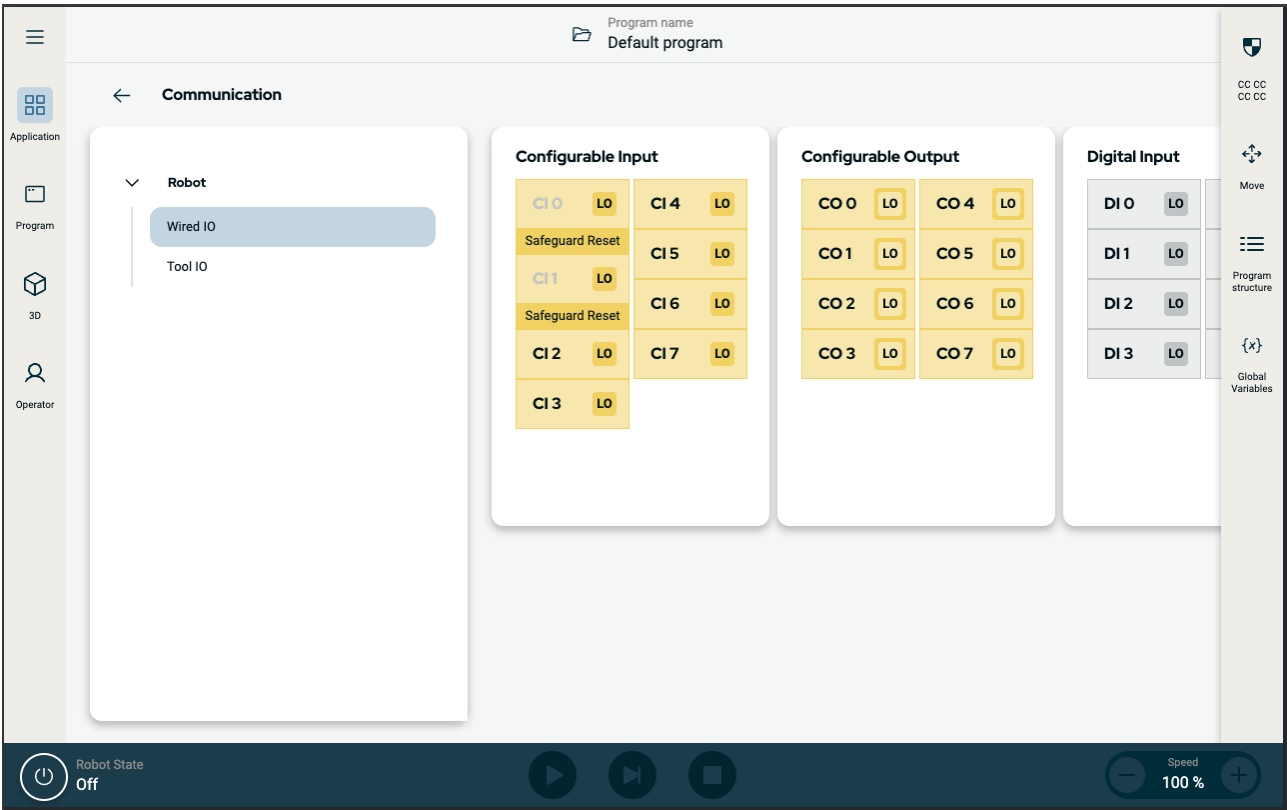

Figure 2.7: Communication screen displaying I/Os.

Software Name: PolyScope X
 Software Version: 10.7
 Document Version: 10.8.48

25. Glossary

Stop Category 0

Robot motion is stopped by immediate removal of power to the robot. It is an uncontrolled stop, where the robot can deviate from the programmed path as each joint brake as fast as possible. This robot stop is used if a safety-related limit is exceeded or in case of a fault in the safety-related parts of the control system. For more information, **see ISO 13850 or IEC 60204-1**.

Stop Category 1

Robot motion is stopped with power available to the robot to achieve the stop and then removal of power when the stop is achieved. It is a controlled stop, where the robot will continue along the programmed path. Power is removed as soon as the robot stands still. For more information, **see ISO 13850 or IEC 60204-1**.

Stop Category 2

A controlled stop with power left available to the robot. The safety-related control system monitors that the robot stays at the stop position. For more information, **see IEC 60204-1**.

Category 3

The term *Category* should not be confused with the term *Stop Category*. *Category* refers to the type of architecture used as basis for a certain *Performance Level*. A significant property of a *Category 3* architecture is that a single fault cannot lead to loss of the safety function. For more information, **see ISO 13849-1**.

Performance Level

A Performance Level (PL) is a discrete level used to specify the ability of safety-related parts of control systems to perform a safety functions under foreseeable conditions. PLd is the second highest reliability classification, meaning that the safety function is extremely reliable. For more information, **see ISO 13849-1**.

Diagnostic coverage (DC)

is a measure of the effectiveness of the diagnostics implemented to achieve the rated performance level. For more information, **see ISO 13849-1**.

MTTFd

The Mean time to dangerous failure (MTTFd) is a value based on calculations and tests used to achieve the rated performance level. For more information, **see ISO 13849-1**.

Integrator

The integrator is the entity that designs the final robot installation. The integrator is responsible for making the final risk assessment and must ensure that the final installation complies with local laws and regulations.

Risk assessment

A risk assessment is the overall process of identifying all risks and reducing them to an appropriate level. A risk assessment should be documented. Consult **ISO 12100** for further information.

Collaborative robot application

The term *collaborative* refers to collaboration between operator and robot in a robot application. See precise definitions and descriptions in ISO 10218-1 and ISO 10218-2.

Safety configuration

Safety-related functions and interfaces are configurable through safety configuration parameters. These are defined through the software interface, see part .

25.1. Index

B

Base 84, 133

bla 135

C

Configurable I/O 50

Control Box 8, 38, 47, 49, 59, 62-63, 97, 131

Conveyor Tracking 49

E

Elbow 84, 133

Ethernet 62

EtherNet/IP 62

F

Freedrive 34-35

G

General purpose I/O 50

I

I/O 47, 50



M

Mini Displayport 61

MODBUS 62

Mounting bracket 8, 131

N

Normal 33

Normal mode 142

P

PolyScope 8, 34-35

PolyScope X 134

R

Recovery 34-35

Recovery mode 142

Reduced 33

Reduced mode 142-144

risk assessment 8, 13, 24, 28, 131

robot arm 47, 132-133

Robot arm 97

robot cable 65-66

Robot Moving 144

Robot Not Stopping 144

S

Safeguard Reset 143

Safety Configuration 21

Safety functions 26, 28

Safety I/O 26, 32, 50-51

Safety instructions 75

Safety planes 144

Safety Settings 13

Shoulder 84, 133

System Emergency stop 143

System Emergency Stop 144

T

Teach Pendant 8, 38, 59, 97, 131

Tool Center Point 142

Tool Flange 133

Tool I/O 67

Trigger Reduced Plane 33

U

UR Forum 10

UR+ 10

UR+ Partner Program 10

W

Wrist 133





Software Name: PolyScope X
Software Version: 10.7
Document Version: 10.8.48